



VS-616G5 Series (Revision F) Programming Manual

Constant Torque Inverter with Adaptive Vector Control (AVC™)

WARNING

PRECAUTIONS

- 1) Only turn ON the input power supply after replacing the front cover. Do not remove the cover while the inverter is powered up.
- 2) When the retry function (parameter *L5-02*) is selected, do not approach the inverter or the load, since it may restart suddenly after being stopped.
- 3) Since the Stop key can be disabled by a function setting, install a separate emergency stop switch.
- 4) Do not touch the heatsink or braking resistor, due to very high temperatures.
- 5) Since it is very easy to change operation speed from low to high speed, verify the safe working range of the motor and machine before operation.
- 6) Install a separate holding brake, if necessary.
- 7) Do not check signals during operation.
- 8) All inverter parameters have been preset at the factory. Do not change the settings unless required.

Failure to observe these precautions may result in equipment damage, serious personal injury or death.

NOTICE

Printed April 1999. The information contained within this document is the proprietary property of Yaskawa Electric America, Inc., and may not be copied, reproduced or transmitted to other parties without the expressed written authorization of Yaskawa Electric America, Inc.

No patent liability is assumed with respect to the use of the information contained herein. Moreover, because Yaskawa is constantly improving its high-quality products, the information contained in this manual is subject to change without notice. Every precaution has been taken in the preparation of this manual. Nevertheless, Yaskawa assumes no responsibility for errors or omissions. Neither is any liability assumed for damages resulting from the use of the information contained in this publication.

Contents

<u>Section</u>	<u>Description</u>	<u>Page</u>
	INTRODUCTION	5
	VS-616G5 PARAMETER TREE	7
A	INITIALIZATION PARAMETERS	9
A1	Initialization Set-up	9
A2	User's Parameters	11
B	APPLICATION PARAMETERS	11
B1	Sequence	11
B2	DC Braking	16
B3	Speed Search	18
B4	Delay Timers	19
B5	PID Control	20
B6	Reference Hold	26
B8	Energy Saving	27
B9	Zero Servo	29
C	TUNING PARAMETERS	30
C1	Accel/Decel	30
C2	S-Curve Accel/Decel	32
C3	Motor Slip Compensation	34
C4	Torque Compensation	36
C5	ASR Tuning	37
C6	Carrier Frequency	40
C7	Hunting Prevention	42
C8	Factory Tuning	44
D	REFERENCE PARAMETERS	45
D1	Preset References	45
D2	Reference Limit	47
D3	Jump Frequencies	47
D4	Sequence	48
D5	Torque Control	49
E	MOTOR PARAMETERS	53
E1	V/f Pattern 1	53
E2	Motor 1 Set-up	59
E3	Motor 2 Set-up	61
E4	Motor 2 V/F Pattern	62
E5	Motor 2 Set-up	62
F	OPTION PARAMETERS	63
F1	PG Option Set-up	63
F2	AI-14 Set-up	67
F3	DI-08, 16 Set-up	48
F4	AO-08 Set-up	49
F5	DO-02 Set-up	50
F6	DO-08 Set-up	51
F7	PO-36F Set-up	52
F8	SI-F/G Option Set-up	73
F9	CP-916 Option Set-up	74
H	CONTROL CIRCUIT TERMINAL PARAMETERS	76

<u>Section</u>	<u>Description</u>	<u>Page</u>
H1	Digital Inputs	76
H2	Digital Outputs	88
H3	Analog Inputs	95
H4	Analog Outputs	99
H5	Serial Communication Set-up	101
L	PROTECTION	103
L1	Motor Overload	103
L2	Power Loss Ridethrough	104
L3	Current Limit/Stall Prevention	107
L4	Reference Detection	111
L5	Fault Restart	112
L6	Torque Detection	113
L7	Torque Limit	115
L8	Hardware Protection	116
O	OPERATOR	120
O1	Monitor Selection	120
O2	Key Selection	122
	AUTO-TUNING	125
Appendix	VS-616G5 PARAMETER LIST	126

Introduction

Thank you for purchasing Yaskawa's VS-616G5 high performance vector inverter. The G5 employs the latest hardware and software technology to provide unmatched performance, reliability and application flexibility.

The G5 flexible control mode architecture allows four choices of motor control technology for your application:

- Open Loop Vector is best for most applications, as it offers Adaptive Vector Control technology (AVC™) for precise speed regulation, quick response and high starting torque.
- Closed Loop Flux Vector is the choice for applications requiring torque control, very precise speed regulation and full torque control at zero speed.
- V/f (Volts per Hertz) mode with Yaskawa's proprietary full range auto-torque boost provides ideal control for multi-motor applications.
- Closed Loop V/f allows encoder feedback for use with the Volts/hertz mode.

Use the following key to determine which control mode and access level are available for each parameter.

<u>No.</u>	<u>Parameter Name</u>	<u>LCD Display</u>	V/f	V/f w/PG	Open Loop Vector	Flux Vector
A1-00	Language Selection	Select Language	Q	Q	Q	Q

Q: Quick-Start Level, selected parameters for maintenance-level programming

B: Basic Level, selected parameters for basic programming in most applications

A: Advanced Level, all parameters for advanced programming in special applications

The menu structure for all access levels are the same for the Operation, Initialize, Auto-tuning and Modified constants sections. The Programming section menu structure for each access level is as follows:

Quick-Start Access Level Structure

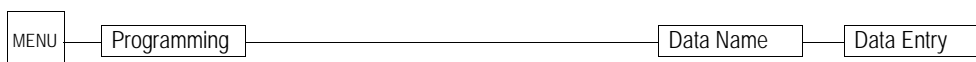

Basic Access Level Structure

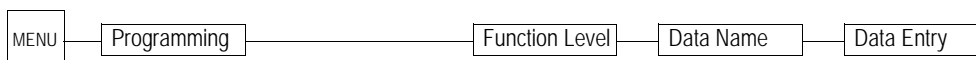

Advanced Access Level Structure

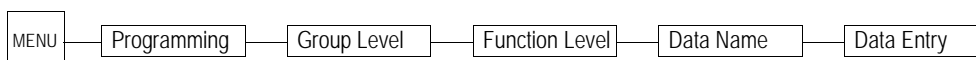

Software Version Explanation

Yaskawa recognizes the need to continuously improve product quality. This product may receive feature enhancements in the form of software or hardware changes. New programming parameters will be added to the latest programming manual. When a new parameter is added a software version note will be placed next to the parameter.

Software Version Example:

A1-00 *Language Selection*

Select Language

0	0	0	0
---	---	---	---

Select the language displayed on the digital operator according to the following table:

Setting	Description
0	English (<i>factory default</i>)
1	Japanese
2	Deutsche <1110> ← - -
3	Francais <1110> ← - -
4	Italiano <1110> ← - - -
5	Espanol <1110> ← - - -
6	Portugues <1110> ← - -

This version note <1110> indicates that five additional languages have been added with software version 1110.

The part number of the main control printed circuit board on the drive reflects the software version. The software version normally increases to a higher number with newer versions. Please consult the factory for details.

PCB Part Number Example: ETC615991-S1110 ← Software version 1110

The VS-616G5 ships preset to open loop vector control, quick-start access level. This publication describes all Quick-Start, Basic and Advanced parameters. For installation and simplified Quick-Start parameters, please refer to YEA-TOA-S616-10.12C.

VS-616G5 Parameter Tree

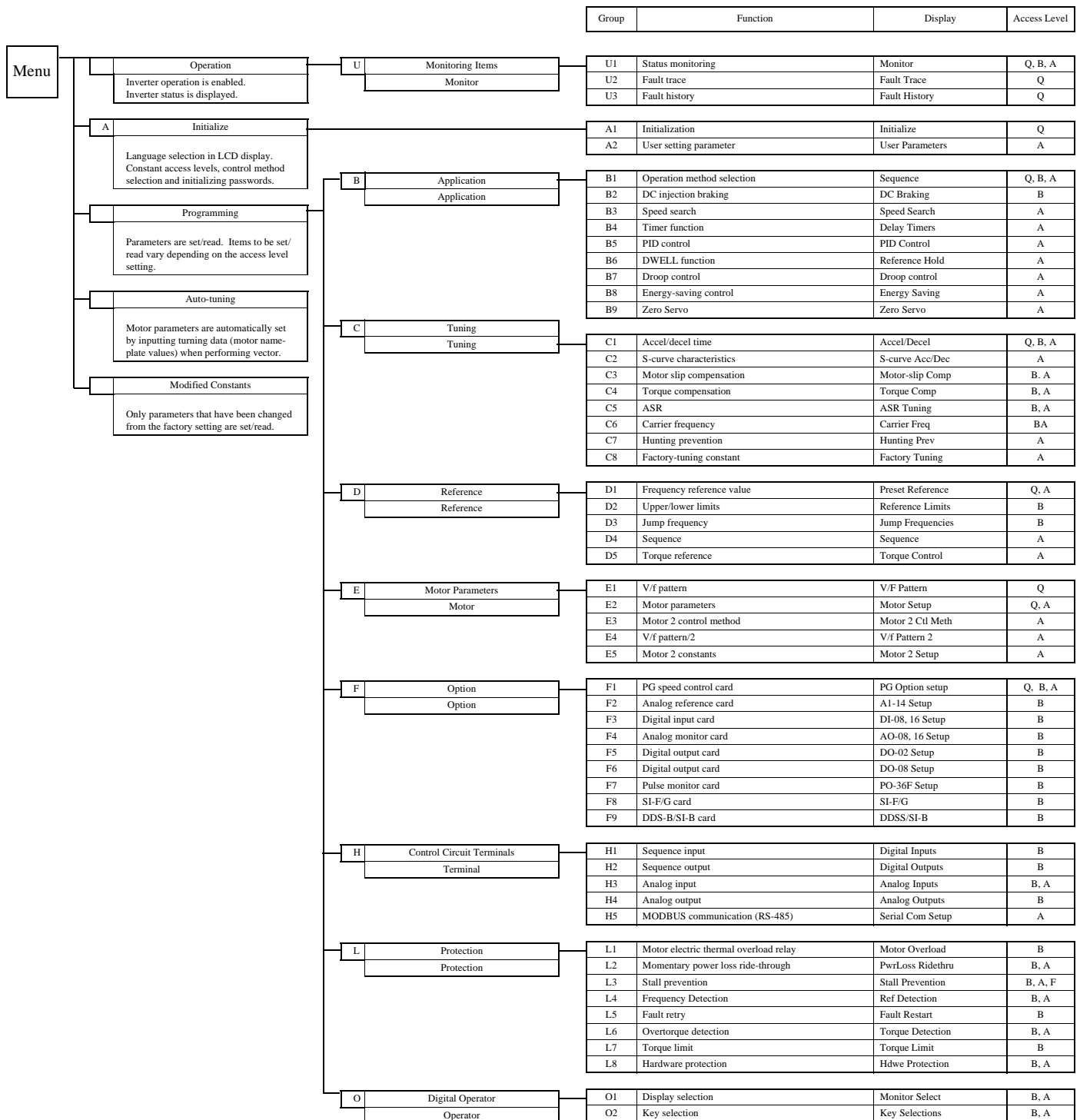



This page intentionally left blank.

V/f	V/f w/PG	Open Loop Vector	Flux Vector
-----	----------	------------------	-------------

Main Menu: Initialize <ENTER>

A Initialization Parameters

A1 Initialization Set-up

A1-00 *Language Selection*

Select Language

0	0	0	0
---	---	---	---

Select the language displayed on the digital operator according to the following table:

Setting	Description
0	English (<i>factory default</i>)
1	Japanese
2	Deutsch <1110>
3	Francais <1110>
4	Italiano <1110>
5	Espanol <1110>
6	Portugues <1110>

A1-01 *Parameter Access Level*

Access Level

0	0	0	0
---	---	---	---

This parameter allows the “masking” of parameters according to user level. See the following table:

Setting	Description
0	Operation Only
1	User Program - Accesses parameters selected by OEM (A2-01 to A2-32).
2	Quick Start Level (<i>factory default</i>) - For maintenance-level programming.
3	Basic Level - For basic programming in most applications.
4	Advanced Level - For advanced programming in special applications.

A1-02 *Control Method Selection*

Control Method

0	0	0	0
---	---	---	---

Select the control method best suited for your application.

Setting	Description
0	V/f Control - For general-purpose and multiple motor applications.
1	V/f with PG Feedback - For general-purpose applications requiring closed loop speed control.
2	Open Loop Vector (<i>factory default</i>) - For applications requiring precise speed control, quick response and higher torque at low speeds (150% torque below 1Hz).
3	Flux Vector - For applications requiring very precise speed and torque control at a wide speed range including 0 speed. Uses encoder feedback.

A1 Initialization Set-up

V/f	V/f w/PG	Open Loop Vector	Flux Vector
-----	----------	------------------	-------------

A1-03 Operator Status

Init Parameters

0	0	0	0
---	---	---	---

Use this parameter to reset the inverter to its factory default settings. Initialize the inverter after changing the control PCB, or after selecting language (A1-00), control method (A1-02), or inverter capacity (O2-04).

Setting	Description
0	No Initialization (<i>factory default</i>)
1110	User Initialization - resets the inverter to user-specified initial values. To set user-specified initial values, make all required changes to parameter settings, then set O2-03 to "1". The inverter will memorize all current settings as the user-specified initial values. Up to 50 changed parameters can be stored.
2220	2-Wire Initialization - terminal 1 becomes FWD run command and terminal 2 becomes REV run command. All other parameters are reset to their original factory default settings.
3330	3-Wire Initialization - terminal 1 becomes run command, terminal 2 becomes stop command and terminal 3 becomes FWD/REV run selection. All other parameters are reset to their original factory default settings.

A1-04 Password Entry

Enter Password

0	0	0	0
---	---	---	---

Parameter A1-04 is used to enter a password into the inverter, to be able to make adjustments to locked parameters.

Password protection is provided for:

- A1-01 Access Level
- A1-02 Control Method
- A1-03 Initialization
- A2-01 to A2-32 User Parameters (If selected)

V/f	V/f w/PG	Open Loop Vector	Flux Vector
-----	----------	---------------------	----------------

A2 User's Parameters

The user can select up to 32 parameters for quick-access programming. By setting the user access level (A1-01) to "User Program", only the parameters selected in function A2 can be accessed by the user.

Parameter A1-01 must be set to 4 (advanced access level) to input parameter numbers into A2-01 through A2-32, and then A1-01 must be set to 1 (User Level) for only the user selected parameters to be viewed.

Main Menu: Programming <ENTER>

B Application Parameters

B1 Sequence

B1-01 Frequency Reference Selection

Reference Source

B1-02 Operation Method Selection

Run Source

Q	Q	Q	Q
Q	Q	Q	Q

Frequency reference and run command can be set independently as shown below:

Setting	Description
0	Command from digital operator
1	Command from control circuit terminal (<i>factory default</i>)
2	Command from serial communication
3	Command from option card
4	EWS (Reference from CP-717)* <1110> This setting will be used with the CP-717 to run and change the reference through DP-RAM.

* Setting parameter B1-01 or B1-02 to 4 allows reference and/or run source from CP-717 when either CP-916 or CP-216 option cards are installed.

By depressing the LOCAL/REMOTE key on the digital operator, the operation mode can be selected as shown below:

- Local: Operation according to frequency reference and run command from digital operator.
- Remote: Operation according to frequency reference and run command set by *B1-01* and *B1-02*.

The digital operator is reset to remote operation when power is cycled.

V/f	V/f w/PG	Open Loop Vector	Flux Vector
-----	----------	------------------	-------------

B1-03 Stopping Method Selection

Stopping Method

0	0	0	0
---	---	---	---

This function selects the stopping method suitable for the particular application.

Setting	Description
0	Ramp to stop (<i>factory default</i>)
1	Coast to stop
2	DC injection to stop
3	Coast to stop with timer

- Ramp to Stop (*B1-03 = "0"*)

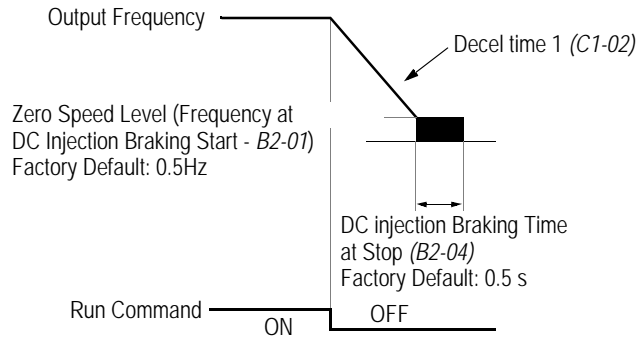

Figure 1 Stopping Method - Ramp to Stop

Upon removal of the FWD (REV) run command, the motor decelerates at a rate determined by the time set in deceleration time 1 (*C1-02*) and DC injection braking is applied after the minimum output frequency (*E1-09*) has been reached. If the deceleration time is set too short or the load inertia is large, an overvoltage fault (OV) may occur during deceleration. In this case, increase the deceleration time or install an optional braking transistor and/or braking resistor (braking transistors are provided as standard for units 230V 7.5kW and smaller, 460V 15kW and smaller).

Braking torque: without braking resistor, approx. 20% of motor rated torque
 with braking option, approx. 150% of motor rated torque

V/f	V/f w/PG	Open Loop Vector	Flux Vector
-----	----------	------------------	-------------

- Coast to Stop ($B1-03 = "1"$)

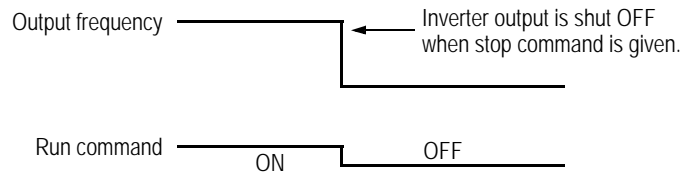

Figure 2 Stopping Method - Coast to Stop

Upon removal of the FWD (REV) run command, the motor starts to coast. After a stop command is given, a run command is accepted and operation will start after the minimum baseblock time ($L2-03$) elapses. If there is a possibility that a run command might be entered before the motor has come to a stop, the speed search function (B3) or Coast to Stop with Timer 1 ($B1-03 = "3"$) should be employed.

- DC Injection Braking to Stop ($B1-03 = "2"$)

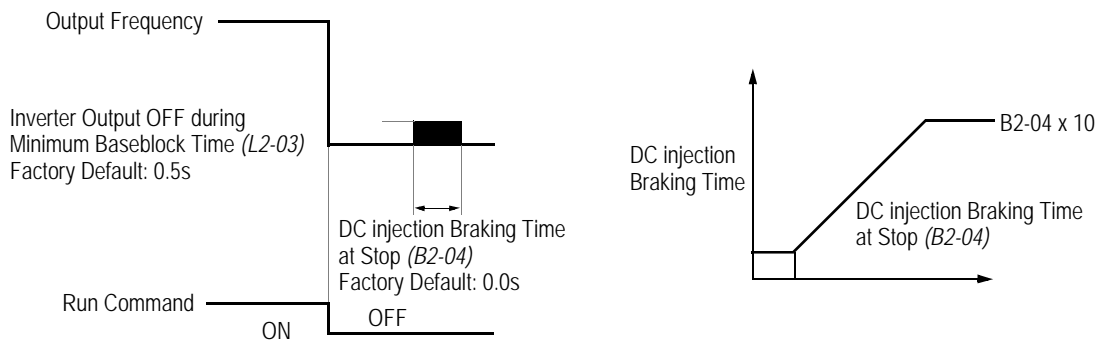

Figure 3 Stopping Method - DC Injection Braking to Stop

Upon removal of the FWD (REV) run command, the motor brakes to stop, according to the DC injection braking time at stop set in $B2-04$. If this value is set to "0" (*factory default*), DC injection braking is disabled, and the motor coasts to stop. When choosing this function, note that the actual stop time is the time set in $B2-04$ multiplied by 10 (see Figure 3 above). This stopping method is disabled during flux vector control. Braking duty cycle should allow excess motor heat to dissipate.

V/f	V/f w/PG	Open Loop Vector	Flux Vector
-----	----------	------------------	-------------

- Coast to Stop with Timer 1 (*B1-03 = "3"*)

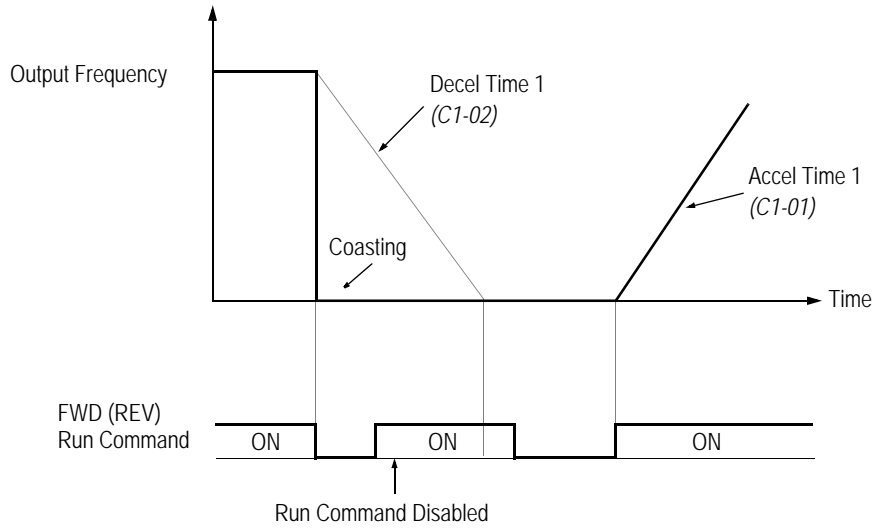

Figure 4 Stopping Method - Coast to Stop w/ Timer

After a stop command is given, a run command is not accepted while the coast to stop timer elapses (same as Decel 1). After the timer runs out, another run command must be given for the inverter to begin acceleration. This stopping method is disabled during flux vector control.

B1-04 Prohibition of Reverse Operation

Reverse Oper

B	B	B	B
---	---	---	---

A “reverse run disabled” setting does not allow a reverse run command from the control circuit terminal or the digital operator. This setting is used in applications where a reverse run command is undesirable.

Setting	Description
0	Reverse run enabled (<i>factory default</i>)
1	Reverse run disabled

V/f	V/f w/PG	Open Loop Vector	Flux Vector
-----	----------	------------------	-------------

B1-05 Operation Selection at Zero Speed

Zero Speed Oper

-	-	-	A
---	---	---	---

During flux vector control, select an operation mode to be employed when the frequency reference (analog input) drops below the minimum output frequency (*E1-09*). During V/f or open loop vector control, baseblock is applied when the output frequency drops below the minimum output frequency (*E1-09*).

Setting	Description
0	<i>E1-09</i> disabled, run according to frequency reference (<i>factory default</i>)
1	Baseblock
2	Run at minimum output frequency (<i>E1-09</i>)
3	Zero-speed operation (internal speed reference is set to "0")

B1-06 Input Scan Time

Cntl Input Scans

B	B	B	B
---	---	---	---

This parameter selects the microprocessor scan time for reading sequence input data from the control circuit terminals.

Setting	Description
0	2ms scan time for 2 scans
1	5ms scan time for 2 scans (<i>factory default</i>)

Set to "0" when a quicker response is needed from the control circuit terminals.

B1-07 Operation Selection After Switch to Remote Mode *LOC/REM RUN Sel*

A	A	A	A
---	---	---	---

Parameter b1-07 determines how the inverter will function when switching between local and remote operation. This function prevents the motor from running when switching between local/remote and the inverter is controlled from the digital operator.

Setting	Description
0	(Cycle Extrn RUN) - If the run command is closed when switching from local control to remote control, the inverter will not run. <i>The run command must be cycled for the inverter to run. (factory default)</i>
1	(Accept Extrn RUN) - If the run command is closed, when switching from local control to remote control, the inverter will run.

V/f	V/f w/PG	Open Loop Vector	Flux Vector
-----	----------	------------------	-------------

B1-08 Run Command Acceptance During Programming RUN CMD at PRG

A	A	A	A
---	---	---	---

As a safety precaution the drive will not respond to a change in the run command when the digital operator is being used to set or adjust parameters. This parameter will allow the drive to accept or reject a change in the run command when the digital operator is being used to change or adjust parameters. <1110>

Table 1:

Setting	Description
0	Run command is disabled when drive is in the programming mode. <i>(factory default)</i>
1	Run command is enabled when the drive is in the program mode

B2 DC Braking

B2-01 DC Braking Frequency (Zero Speed Level)

DCInj Start Freq

B	B	B	B
---	---	---	---

Setting Range: 0.0 to 10.0Hz
 Factory Default: 0.5Hz

Sets the frequency at which DC injection braking (or initial excitation for flux vector control) starts, in units of 0.1 Hz. When *B2-01* < *E1-09*, DC injection braking starts from the minimum frequency reference (*E1-09*).

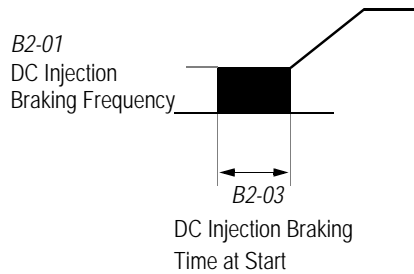

Figure 5 DC Injection Braking at Starting

B2-02 DC Braking Current

DCInj Current

B	B	B	-
---	---	---	---

Setting Range: 0 to 100%
 Factory Default: 50%

DC injection braking current is set as a percentage of inverter rated current. In flux vector control mode, initial excitation is performed according to the motor no-load current set in *E2-03*. This parameter should not be set unnecessarily high or motor overexcitation may occur.

V/f	V/f w/PG	Open Loop Vector	Flux Vector
-----	----------	------------------	-------------

B2-03 DC Braking Time at Start

DCInj Time@Start

B	B	B	B
---	---	---	---

Setting Range: 0.00 to 10.00s
 Factory Default: 0.00s

DC injection braking at start can be used to stop a spinning motor (or when motor rotation direction is unknown) prior to running. DC injection braking time at start (or initial excitation for flux vector control) is set in units of 0.1 second. When *B2-03* is set to “0”, DC injection braking is disabled and acceleration starts from the minimum output frequency.

B2-04 DC Braking Time at Stop

DCInj Time@Stop

B	B	B	B
---	---	---	---

Setting Range: 0.00 to 10.00s
 Factory Default: 0.00s

DC injection braking time at stop (or initial excitation for flux vector control) is set in units of 0.1 second. When *B2-04* is set to “0”, DC injection braking is disabled, and the inverter output shuts OFF.

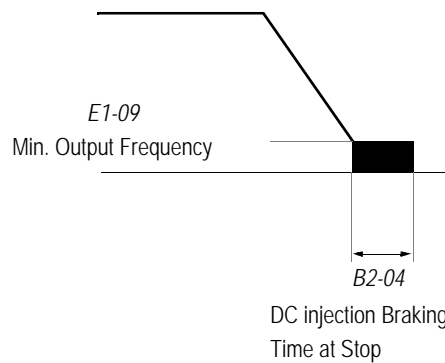

Figure 6 DC Injection Braking Time at Stop

When coast to stop is selected as the stopping method (*B1-03*), DC injection braking at stop is disabled.

B2-08 Magnetic Flux Compensation Level <1110>

FieldComp

-	-	A	A
---	---	---	---

Setting Range: 0 to 500%
 Factory Default: 0%

This parameter allows the magnetizing motor flux to be boosted when starting the motor. This parameter will facilitate a quick ramp-up of the torque reference and magnetizing current reference to reduce motor slip during start. A setting of 100% equals motor no-load current *E1-09*. This flux level will be applied below *Minimum Output Frequency (E1-09)* until the *DC Injection Time at Start (B2-03)* expires. This parameter is useful when starting motors that are relatively larger than the inverter, due to the requirement for increased magnetizing current. This parameter may also compensate for reduced starting torque due to motor circuit inefficiencies.

V/f	V/f w/PG	Open Loop Vector	Flux Vector
-----	----------	------------------	-------------

B3 Speed Search

When starting into a coasting motor, use the speed search command or DC injection braking at start, to prevent a drive trip and motor burnout.

This function allows the restart into a coasting motor without the necessity to stop. It is useful during inverter bypass operation, when switching between the motor receiving power directly from the line and from the inverter. Two interlocking contactors must be employed for commercial power switchover to prevent line power from being applied to the inverter output terminals.

Set the multi-function contact input selection (*H1-01* to *H1-06*) to “61” (start search command from maximum output frequency), “62” (start search command from the set frequency), or “64” (start search command from the SFS frequency when baseblock is applied).

B3-01 Speed Search after Run Command

SpdSrch at Start

A	-	A	-
---	---	---	---

Setting	Description
0	Speed search disabled, the motor accelerates to the set frequency from the min. frequency reference after run command is given (<i>factory default</i>).
1	Speed search enabled after run command is given, according to multi-function contact input selection. When using an encoder, the motor accelerates/ decelerates to the set frequency from the motor speed.

Note: This parameter is disabled except when (A1-02=1) (V/F w/PG Fdbk) or 3 (Flux Vector)

B3-02 Speed Search Detection Current Level

SpdSrch Current

A	-	A	-
---	---	---	---

Setting Range: 0 to 200%
 Factory Default: 150%

After power loss and recovery, speed search begins to ramp the frequency down from a specified point in order to locate the frequency of the spinning motor. During initial speed search the inverter’s output current exceeds the speed search detection current level. This level is set as a percentage of inverter rated current. When the inverter’s output current is less than the speed search detection level, the frequency is interpreted as the speed agree level, and the inverter accelerates/decelerates to the specified frequency.

Note: Factory setting defaults to 150 when A1-02=0 (V/F Control). When A1-02=2 (Open Loop Vector), the default is 100.

V/f	V/f w/PG	Open Loop Vector	Flux Vector
-----	----------	------------------	-------------

B3-03 Speed Search Deceleration Time

SpdSrch Dec Time

A	-	A	-
---	---	---	---

Setting Range: 0.1 to 10.0s
 Factory Default: 2.0s

Sets deceleration time during speed search in units of 0.1 second. When speed search deceleration time is set to 0.0 second, speed search is disabled. The speed search deceleration time should be set to be somewhat faster than the decel rate of coasting motor. Build an input sequence so that the speed search command is input at the same time or prior to the FWD (REV) run command. If the run command is input before the search command, the search command is not effective. Below is a timing diagram of the search command input:

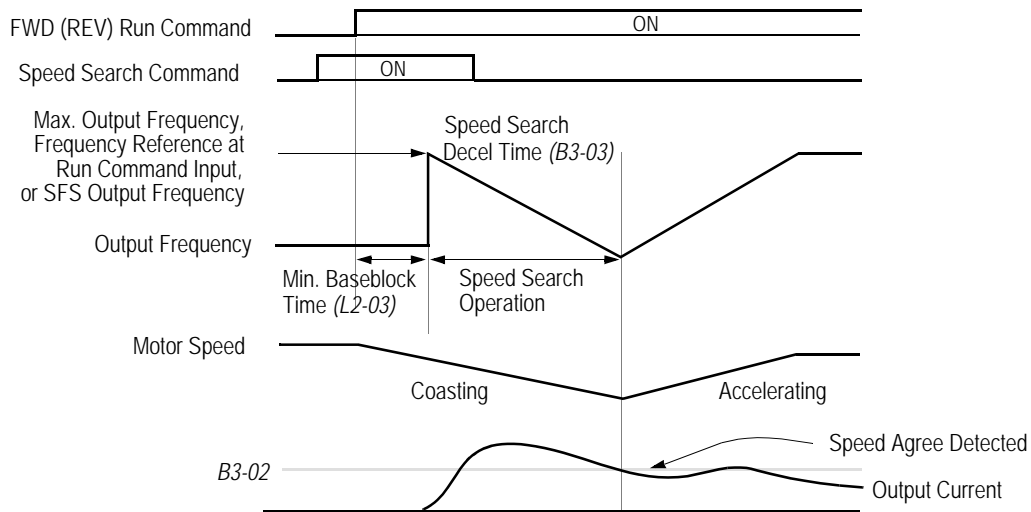

Figure 7 Search Command Input Timing Diagram

B4 Delay Timers

The inverter input and output contacts can be used in place of an external timer. When multi-function contact input (*H1-__ = "18"*) is closed, a multi-function contact output (*H2-__ = "12"*) can be set to close after the On-delay time (*B4-01*) has expired. When multi-function contact input (*H1-__ = "18"*) is opened, a multi-function contact output (*H2-__ = "12"*) can be set to open after the Off-delay time (*B4-01*) has expired. This function operates independently of any action the inverter is performing.

B4-01 On-delay Timer

Delay-ON Timer

A	A	A	A
---	---	---	---

Setting Range: 0.0 to 100.0s
 Factory Default: 0.0s

Sets the ON-delay time in units of 0.1 second. The multi-function input must be "closed" for longer than the ON-delay timer for the multi-function output to close.

Vf	Vf w/PG	Open Loop Vector	Flux Vector
----	---------	------------------	-------------

B4-02 Off-delay Timer

Delay-OFF Timer

A	A	A	A
---	---	---	---

Setting Range: 0.0 to 100.0s

Factory Default: 0.0s

Sets the OFF-delay time in units of 0.1 second. The multi-function input must be “open” for longer than the OFF-delay timer for the multi-function output to open.

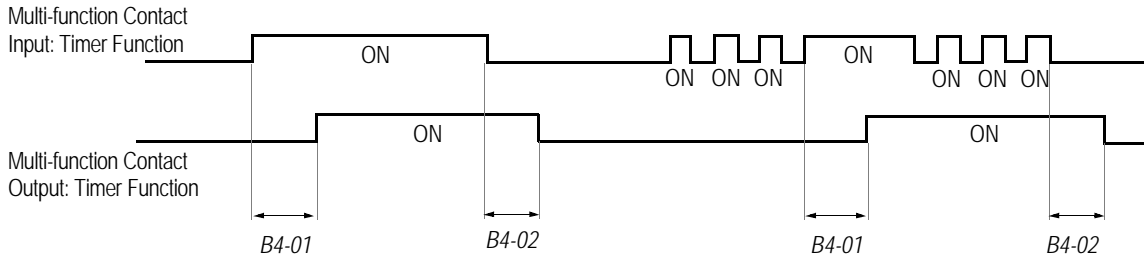

Figure 8 Timing Diagram of Timer Function

B5 PID Control

The Proportional, Integral and Derivative (PID) control function provides closed-loop control and regulation of a system variable such as temperature or pressure. A control signal based on the difference (or proportion) between a feedback signal and a desired setpoint is produced. Integration and derivative calculations are then performed on this signal, based upon the PID parameter settings (B5-01 to B5-08), to minimize deviation, for more precise control.

Proportional - P

PID refers to the type of action used to control modulating equipment such as valves or dampers. With **proportional** control, a control signal based on the difference between an actual condition and a desired condition is produced. The difference, such as that between an actual temperature and setpoint is the “error”. The inverter adjusts its output signal related directly to the error magnitude.

Integral - I

The **integral** action is designed to minimize offset. An integrating term is used to observe how long the error condition has existed, summing the error over time. Once the system has stabilized, the offset would be minimized.

Derivative - D

Overshoot refers to a control loop tendency to overcompensate for an error condition, causing a new error in the opposite direction. **Derivative** action provides an anticipatory function that exerts a “braking” action on the control loop. When combined, the proportional integral, and **derivative** actions provide quick response to error, close adherence to the setpoint, and control stability.

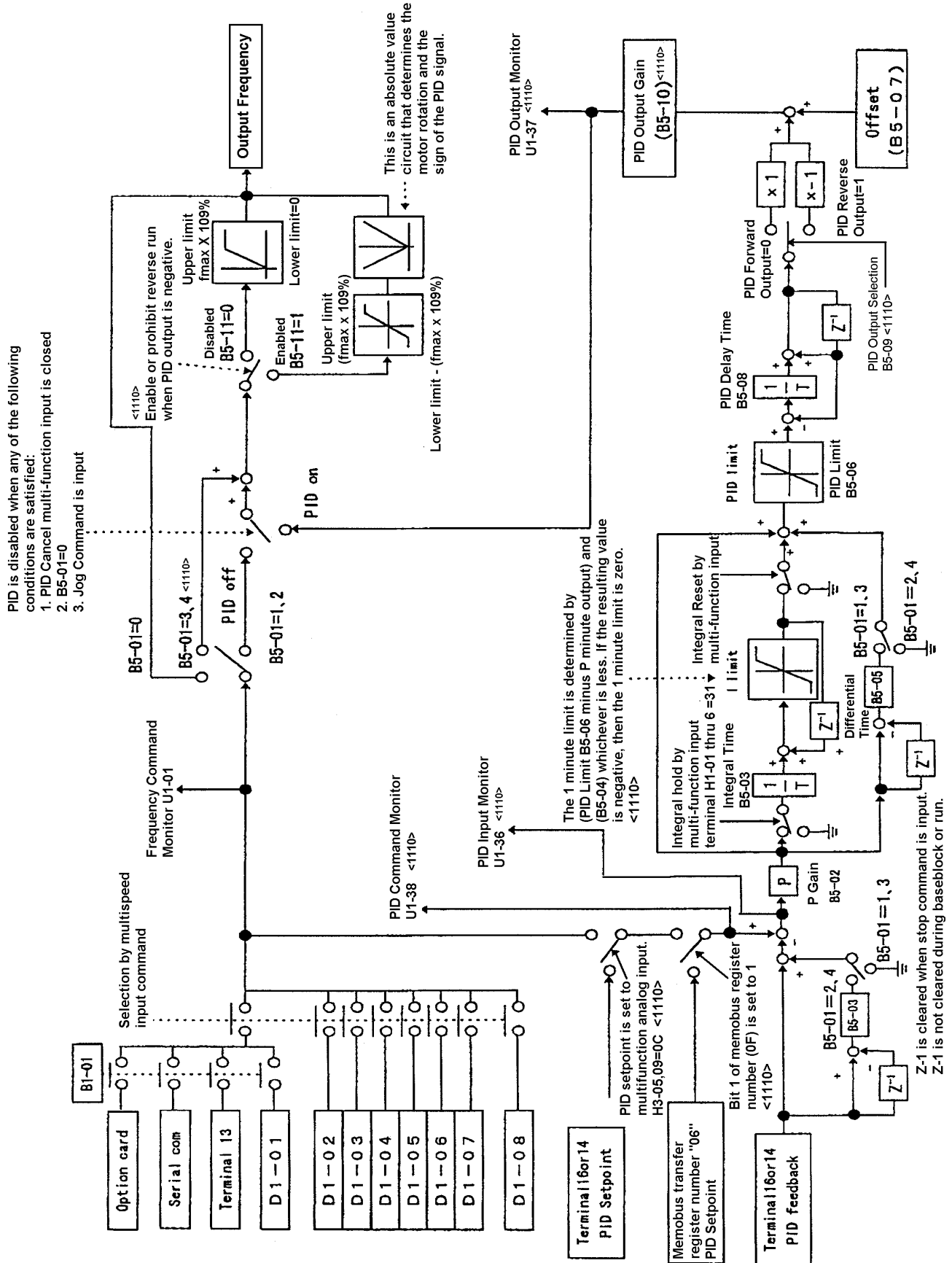

Figure 9 PID Block Diagram

Vf	Vf w/PG	Open Loop Vector	Flux Vector
----	---------	------------------	-------------

B5-01 PID Control Mode Selection

PID Mode

A	A	A	A
---	---	---	---

To enable PID control, set PID control mode selection to “1” or “4”, according to the description below. Also be sure to set terminal 16 function selection (*H3-05*) to PID feedback (setting: “B”).

Setting	Description
0	PID disabled (<i>factory default</i>)
1	PID enabled (deviation signal is put through derivative control)
2	PID with feed forward (feedback signal is put through derivative control)
3 <small><1110></small>	Reference= Frequency reference + PID output, D is Fdbk
4 <small><1110></small>	Reference= Frequency reference + PID output, D is feed-forward

Notes:

1. PID with feed forward applies control much quicker than normal PID, without waiting for the deviation signal to build up.
2. A PID inverse feedback signal can be selected by inverting the settings for terminal 16 gain and bias.

Then select the PID control intended value setpoint or detected feedback value setpoint as follows:

Intended Value Setting

The control circuit terminal 16 voltage signal (0 to 10V, -10 to 10V) or multi-step speed parameters *H1-03* to *H1-06* can be used to set the PID intended value.

Control circuit terminal 16 voltage signal:

Set reference selection (*B1-01*) to “1”.

Multi-step speed parameters (*H1-03* to *H1-06*):

Set reference selection (*B1-01*) to “0”.

(combination of multi-step speed references and jog frequency reference)

Detected Value Setting (Feedback)

The control circuit terminal 14 current signal (4 to 20mA) or voltage signals (0 to 10V, -10 to 10V) can be used to set the PID detected value.

Control circuit terminal 14 current signal:

Set terminal 14 signal selection (*H3-08*) to “2”.

Control circuit terminal 14 voltage signal:

Set terminal 14 signal selection (*H3-08*) to “0” or “1”.

V/f	V/f w/PG	Open Loop Vector	Flux Vector
-----	----------	------------------	-------------

Notes:

1. I value is reset to "0" when operation stops.
2. The upper limit of the I value can be set by parameter *B5-04*.
 Increase the value of parameter *B5-04* to upgrade control capability by integration. If the control system vibrates and it cannot be stopped by adjusting the integral time, output delay time, etc., decrease the set value of parameter *B5-04*.
3. PID control can be canceled by a multi-function contact input signal.
 By setting any of parameters *H1-01* to *H1-06* to "19" and by closing the contact during running, PID control is disabled and the intended value signal itself is used as a frequency reference signal.

B5-02 PID Control Proportional Gain

PID Gain

A	A	A	A
---	---	---	---

Setting Range: 0.00 to 25.00
 Factory Default: 1.00

The proportional gain is the value by which the deviation signal is multiplied to generate a new frequency reference.

B5-03 PID Control Integral Time

PID I Time

A	A	A	A
---	---	---	---

Setting Range: 0.00 to 360.0 seconds
 Factory Default: 1.00 seconds

The integral calculation sums the deviation over time, which eliminates the offset, thus achieving the intended value. The integral time determines how quickly the integral gain increase is added to the control loop.

B5-04 PID Control Integral Limit

PID I Limit

A	A	A	A
---	---	---	---

Setting Range: 0.0 to 100.0%
 Factory Default: 100.0%

The integral limit value eliminates oscillations and improves stability. This value is set as a percentage of maximum output frequency (*E1-04*).

B5-05 PID Control Derivative Time

PID D Time

A	A	A	A
---	---	---	---

Setting Range: 0.00 to 10.00 seconds
 Factory Default: 0.00 seconds

The derivative calculation attempts to control the remaining overshoot left over after the proportion and integral calculations. If the system is approaching the intended value very rapidly, the derivative control produces a strong braking action to prevent overshoot. If the system is already stable with very little deviation change, derivative control has very little effect. The derivative time is used to dampen oscillations and reduce overshoot, thus improving stability. Setting the derivative time to a larger number produces more braking action in the control system.

V/f	V/f w/PG	Open Loop Vector	Flux Vector
-----	----------	------------------	-------------

B5-06 PID Control Limit

PID Limit

A	A	A	A
---	---	---	---

Setting Range: 0.0 to 100.0%
 Factory Default: 100.0%

The PID limit value further eliminates oscillations and improves stability. This value is set as a percentage of maximum output frequency (E1-04).

B5-07 PID Control Offset

PID Offset

A	A	A	A
---	---	---	---

Setting Range: -100.0% to +100.0%
 Factory Default: 0.0%

The PID offset adds a bias to the calculated PID value, in order to reduce any offset.

B5-08 PID Control Output Primary Delay Time

PID Delay Time

A	A	A	A
---	---	---	---

Setting Range: 0.00 to 100.0 seconds
 Factory Default: 0.00 seconds

The output delay time is used to delay changes in the calculated PID value, which can prevent oscillations and improve stability.

Parameters B5-04 and B5-06 to B5-08 are preset at the factory to optimum values for most applications, hence, do not need to be changed. When tuning a system, first adjust the proportional gain until oscillations are reduced. Then adjust the integral time so that minimal deviation is achieved as quickly as possible, without oscillations. Finally, adjust the derivative time to reduce any overshoot at start-up.

B5-09 PID Output Selection <1110>

Output Level Sel

A	A	A	A
---	---	---	---

The PID output term for the inverter control can be either negative or positive output.

Setting	Description
0	PID Normal or Forward Output (<i>factory default</i>) Increase in the manipulated variable when the process variable is larger than the setpoint and decrease the manipulated variable when the process variable is smaller.
1	PID Reverse or Inverse Output Increase the manipulated variable when the process variable is smaller than the setpoint and decrease the manipulated variable when the process variable is larger than the setpoint.

V/f	V/f w/PG	Open Loop Vector	Flux Vector
-----	----------	------------------	-------------

B5-10 PID Output Gain <1110>

Output Gain

A	A	A	A
---	---	---	---

Setting Range: 0.0 to 25.0
 Factory Default: 1.0

This parameter sets the gain of the PID output. The PID output can be monitored by parameter *U1-37 PID Output Monitor*. Refer to PID Block Diagram Figure 9.

B5-11 PID Output Reverse <1110>

Output Rev Sel

A	A	A	A
---	---	---	---

This parameter is used when the motor is required to change direction during PID operation in response to a negative PID output signal. The PID output can be monitored using parameter *U1-37 PID Output Monitor*.

Setting	Description
0	Zero limit (<i>factory default</i>) When PID output is negative, motor direction is not changed. The PID output is limited to 0.
1	Reverse When PID output is negative the motor will reverse direction.

Note: When *Reverse Prohibit B1-04* is selected, reverse will not operate.

B5-12 Loss of Feedback Action <1110>

Fb Los Det Sel

A	A	A	A
---	---	---	---

This parameter is used to select what action the inverter will take on a loss of PID feedback. A loss of PID feedback occurs when the feedback signal falls below the *B5-13 Feedback Loss Detection Level* for the time set by *B5-14 Feedback Loss Detection Time*.

Setting	Description
0	Disabled (<i>factory default</i>) PID feedback missing detection is disabled.
1	Alarm PID feedback missing detection is enabled. Operation continues after loss of feedback. The text "Fbl" will be displayed on the digital operator.
2	Fault PID feedback missing detection is enabled. The inverter output to the motor is shut off (the motor is stopped) and "Fbl" is displayed on the digital operator.

Vf	Vf w/PG	Open Loop Vector	Flux Vector
----	---------	------------------	-------------

B5-13 *PID Feedback Loss Detection Level* <1110> *Fb los Det Lvl*

A	A	A	A
---	---	---	---

Setting Range: 0 to 100%
 Factory Default: 1%

This parameter sets the level at which a loss of PID feedback is detected. The PID feedback must be at or below this level for the time defined by *B5-14* before a loss of feedback can be detected. A setting of 100% represents 100% of the feedback signal.

B5-14 *PID Output Gain* <1110> *Output Gain*

A	A	A	A
---	---	---	---

Setting Range: 0.0 to 25.0
 Factory Default: 1.0

This parameter sets the gain of the PID output. The PID output can be monitored by parameter *U1-37* *PID Output Monitor*. Refer to PID Block Diagram Figure 9.

B6 Reference Hold

The reference hold or dwell function is used to temporarily hold the output frequency at a set reference, for a set time, and then start it again. This function can be used when driving a permanent magnet motor, or a motor with a heavy starting load. This pause in acceleration allows the magnets in a permanent magnet motor to synchronize with the stator field of the motor, thus reducing traditionally high starting current.

B6-01 *Dwell Frequency Reference at Start* *Dwell Ref @Start*

A	A	A	A
---	---	---	---

Setting Range: 0.0 to 400.0Hz
 Factory Default: 0.0Hz

Sets the dwell frequency reference during acceleration in units of 0.1Hz.

B6-02 *Dwell Time at Start* *Dwell Time@Start*

A	A	A	A
---	---	---	---

Setting Range: 0.0 to 10.0s
 Factory Default: 0.0s

Sets the amount of time that the frequency reference “dwells” during acceleration in units of 0.1s.

B6-03 *Dwell Frequency Reference at Stop* *Dwell Ref @Stop*

A	A	A	A
---	---	---	---

Setting Range: 0.0 to 400.0Hz
 Factory Default: 0.0Hz

Sets the dwell frequency reference during deceleration in units of 0.1Hz.

V/f	V/f w/PG	Open Loop Vector	Flux Vector
-----	----------	------------------	-------------

B6-04 Dwell Time at Stop

Dwell Time @Stop

A	A	A	A
---	---	---	---

Setting Range: 0.0 to 10.0s
 Factory Default: 0.0s

Sets the amount of time that the frequency reference “dwells” during deceleration in units of 0.1s.

B7 Droop Control

The Drooping function reduces the motor speed based on the load torque of the motor.

B7-01 Droop Control Gain

Droop Quantity

-	-	-	A
---	---	---	---

Setting Range: 0.0 to 100.0
 Factory Default: 0.0

Parameter b7-01 sets the amount of motor speed reduction when the motor is producing 100% of rated torque. The actual amount of motor speed reduction is based on the ratio of the amount of motor torque and the maximum output frequency (E1-04).

B7-02 Droop Control Delay Time

Droop Delay Time

-	-	-	A
---	---	---	---

Setting Range: 0.03 to 2.00
 Factory Default: 0.05

Parameter b7-02 sets the response time for the drooping function. Decreasing the droop delay time, will cause the response to become quicker; however, instability may occur.

B8 Energy Saving

This feature can save energy during operation under lightly loaded conditions, by decreasing output voltage, energy-saving operation is made available. Energy saving control is enabled by a **multi-function contact input**, when control mode selection (A1-02) is set to “0” (V/f Control) or “1” (V/f w/PG Fdbk).

Parameters B8-03, B8-04 and B8-05 are for energy savings in the vector modes. B8-01 and B8-02 are only functional in the V/f modes via a multi-function input command. Parameters B8-03, B8-04 and B8-05 are for automatic energy savings in the vector modes.

B8-01 Energy Saving Gain

Energy Save Gain

A	A	-	-
---	---	---	---

Setting Range: 0 to 100%
 Factory Default: 80%

The output voltage during energy-saving operation is the product of the normal V/f settings (E1-03 to E1-10) and the energy saving gain. The output voltage decreases and recovers in the voltage recovery time (L2-04). As the energy saving gain increases, the output voltage increases also. **This feature is only enabled by a multi-function contact input.**

B8 Energy Savings

V/f	V/f w/PG	Open Loop Vector	Flux Vector
-----	----------	------------------	-------------

B8-02 Energy Saving Starting Frequency

Energy Save Freq

A	A	-	-
---	---	---	---

Setting Range: 0.0 to 400.0Hz
 Factory Default: 0.0Hz

After the multi-function contact input for energy-saving operation closes (*HI-__*, setting: “63”), the output voltage is decreased when the output frequency reaches the energy-saving starting frequency. This feature is only enable by multi-function contact input.

B8-03 Automatic Energy Saving <1110>

Energy Save Sel

-	-	A	A
---	---	---	---

This parameter is used to select if Automatic Energy Saving Mode is to be on or off. A multi-function contact input **is not** required to activate Automatic Energy Saving Mode. This mode of operation automatically searches for the optimum motor voltage required to save energy. This function is separate and not to be confused with parameters B8-01 and B8-02. The energy saving mode that utilizes B8-01 and B8-02 requires a multi-function input to be activated for operation. This Automatic Energy Saving Mode selection **does not** require a multi-function input to activate operation.

Setting	Description
0	Disabled (<i>factory default</i>) Energy saving mode will not be activated under light loads.
1	Enabled The energy saving mode will be activated under light loads.

B8-04 Energy Saving Control Gain

Energy Save Gain

-	-	A	A
---	---	---	---

Setting Range: 0 to 10.0
 Factory Default: 0.7

The output voltage during energy-saving operation is the product of the normal V/f settings (*E1-03 to E1-10*) and the energy saving gain. The output voltage decreases and recovers according to the *Energy-Saving Control Time Constant B8-05*. As the energy saving gain increases, the output voltage increases also.

Note: When the control mode A1-02=3, the default factory setting becomes 1.0

B8-05 Energy Control Time-Constant

Energy Save F. T

-	-	A	A
---	---	---	---

Setting Range: 0.00 to 10.00
 Factory Default: 0.50

Parameter *B8-05* sets the response time for the *Automatic Energy Saving* function. Decreasing the *Energy Control Time-Constant*, will cause the response to become quicker; however, instability may occur if this is decreased too much.

Note: When control mode A1-02=3, the default factory setting becomes 0.01.

V/f	V/f w/PG	Open Loop Vector	Flux Vector
-----	----------	------------------	-------------

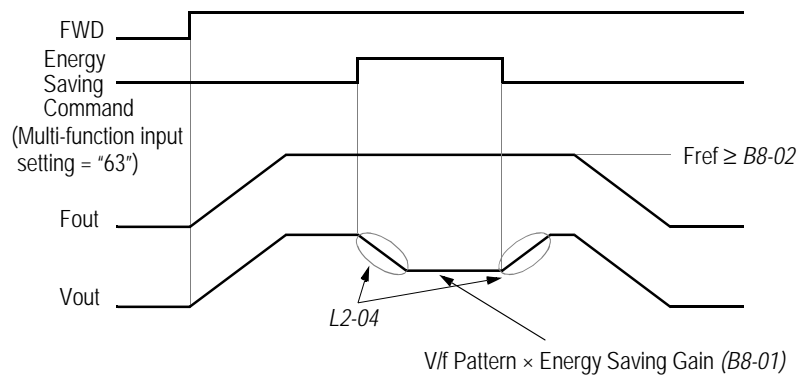

Figure 10 Timing Diagram of Energy Saving Function

B9 Zero Servo

The zero servo function is enabled when the multi-function contact input is set to zero servo command ($H1_ = "72"$). The motor position is then memorized when motor speed feedback is less than the zero speed level ($B2-01$).

B9-01 Zero Servo Gain

Zero Servo Gain

-	-	-	A
---	---	---	---

Setting Range: 0 to 100
 Factory Default: 5

Sets the zero-servo position loop gain. When adjusting the gain, the higher the setting, the quicker the response. However, if the gain is set too high, it can cause overshoot and a possible runaway condition.

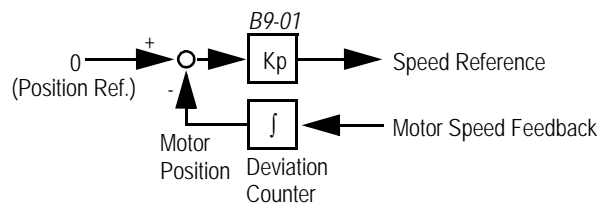

Figure 11 Zero Servo Position Loop

B9-02 Zero Servo Bandwidth

Zero Servo Count

-	-	-	A
---	---	---	---

Setting Range: 0 to 16383 pulses
 Factory Default: 10 pulses

Sets zero servo bandwidth in units of one pulse. During zero servo control, the multi-function contact output ($H2_ = "33"$) is closed until the number of pulses (or bandwidth) is completed. Then the contact output opens.

V/f	V/f w/PG	Open Loop Vector	Flux Vector
-----	----------	------------------	-------------

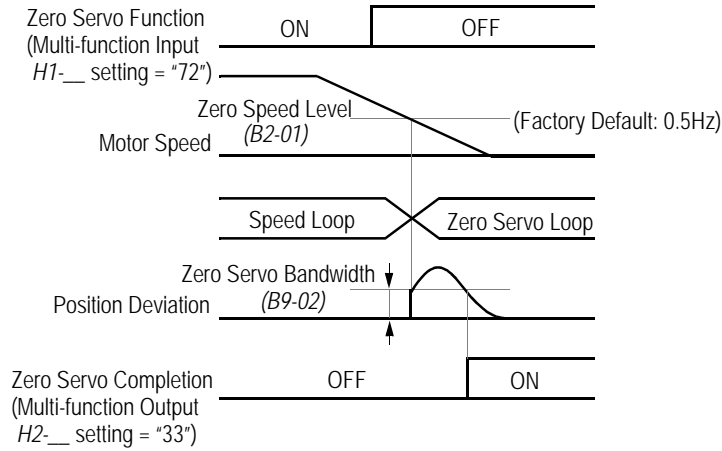

Figure 12 Timing Diagram of Zero Servo Function

Notes:

1. For multi-function contact input function selection, refer to parameters H1-01 to H1-06.
2. For multi-function contact output function selection, refer to parameters H2-01 to H2-03.
3. This function is only available during flux vector control (A1-02 = "3").

C Tuning Parameters

C1 Accel/Decel

C1-01	Acceleration time 1	Accel Time 1
C1-02	Deceleration time 1	Decel Time 1
C1-03	Acceleration time 2	Accel Time 2
C1-04	Deceleration time 2	Decel Time 2
C1-05	Acceleration time 3	Accel Time 3
C1-06	Deceleration time 3	Decel Time 3
C1-07	Acceleration time 4	Accel Time 4
C1-08	Deceleration time 4	Decel Time 4

Q	Q	Q	Q
Q	Q	Q	Q
B	B	B	B
B	B	B	B
A	A	A	A
A	A	A	A
A	A	A	A
A	A	A	A

Setting Range: 0.00 to 6000.0s

Note: Setting range may be 0.00-600.0 or 0.0-6000.0 depending on the setting of parameter C1-10.

Factory Default: 10.0s

Acceleration time sets the time necessary for the output frequency to accelerate from 0Hz to maximum output frequency. Deceleration time sets the time necessary for the output frequency to decelerate from the maximum output frequency to 0Hz.

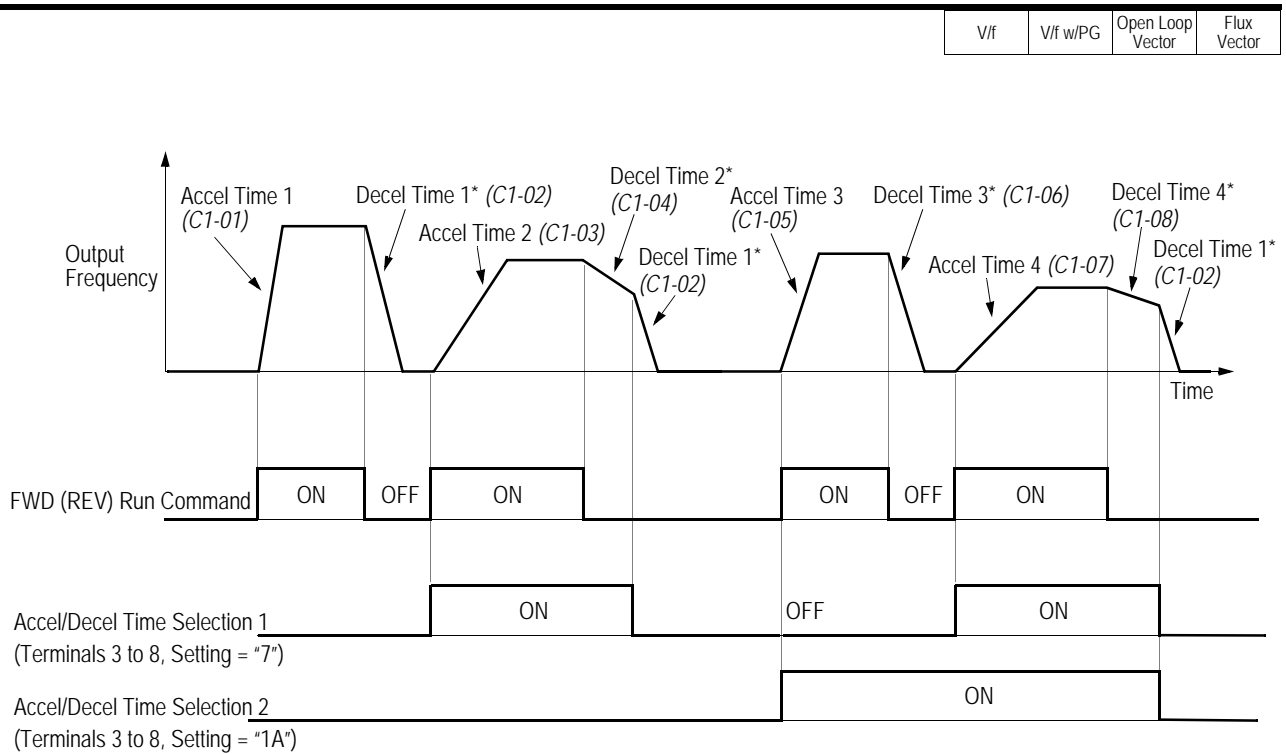

* When "deceleration to stop" is selected ($B1-03 = "0"$)

Figure 13 Timing Diagram of Accel/Decel Time Adjustment

When any of the multi-function contact input selections ($H1-01$ to $H1-06$) are set to "7" and "1A", up to four accel/decel times can then be selected by opening or closing the appropriate accel/decel time selection commands (terminals 3 to 8).

Accel/decel Time Selection 1 Multi-function Input Setting = "7"	Accel/decel Time Selection 2 Multi-function Input Setting = "1A"	Accel Time	Decel Time
Open or not set	Open or not set	C1-01	C1-02
Closed	Open or not set	C1-03	C1-04
Open or not set	Closed	C1-05	C1-06
Closed	Closed	C1-07	C1-08

C1-09 Fast-Stop Time

Fast Stop Time

B	B	B	B
---	---	---	---

Setting Range: 0.00 to 6000.0s
 Factory Default: 10.0s

Fast-stop time is enabled when:

- Multi-function contact input is set to fast-stop command (setting = "15"), and the contact closes.
- The default stopping method when a fault is detected is fast-stop.

Vf	Vf w/PG	Open Loop Vector	Flux Vector
----	---------	------------------	-------------

C1-10 Accel/Decel Time Setting Unit

Acc/Dec Units

A	A	A	A
---	---	---	---

Setting	Description
0	Accel/decel time (C1-01 to C1-09) setting range is in units of 0.01 second. Accel/decel time setting range: 0.00 to 600.00s
1	Accel/decel time (C1-01 to C1-09) setting range is in units of 0.1 second. Accel/decel time setting range: 0.0 to 6000.0s (<i>factory default</i>)

If any of the parameters C1-01 to C1-09 is set to 600.1 seconds or more, C1-10 cannot be set to “0”.

C1-11 Accel/Decel Time Switching Frequency Level

Acc/Dec SW Freq

A	A	A	A
---	---	---	---

Setting Range: 0.0 to 400.0Hz
 Factory Default: 0.0Hz

Accel/decel times can be changed automatically, without using the multi-function contact inputs. Use accel/decel times set in parameters C1-01 and C1-02 when output frequency \geq C1-11. Use accel/decel times set in parameters C1-07 and C1-08 when output frequency $<$ C1-11. When multi-function contact inputs are set for accel/decel selection, this command has priority over automatic change of accel/decel.

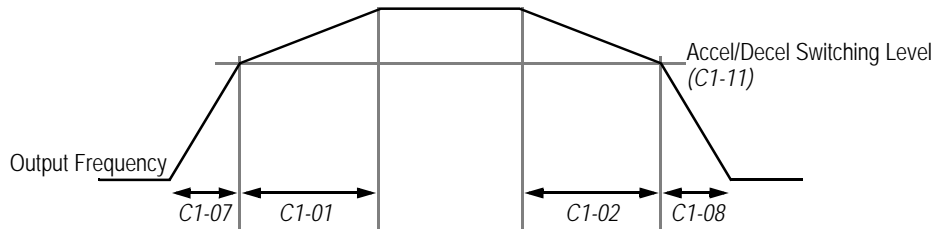

Figure 14 Accel/Decel Switching Level Adjustment

C2 S-Curve Accel/Decel

An S-curve pattern is used to reduce shock and provide smooth transitions during machine acceleration and deceleration. S-curve characteristic time is the time from the output frequency to the set accel/decel time.

C2-01 S-Curve Time at Acceleration Start

SCrv Acc @ Start

A	A	A	A
---	---	---	---

C2-02 S-Curve Time at Acceleration End

SCrv Acc @ End

A	A	A	A
---	---	---	---

C2-03 S-Curve Time at Deceleration Start

SCrv Dec @ Start

A	A	A	A
---	---	---	---

C2-04 S-Curve Time at Deceleration End

SCrv Dec @ End

A	A	A	A
---	---	---	---

Setting Range: 0.00 to 2.50s
 Factory Default: 0.20s

V/f	V/f w/PG	Open Loop Vector	Flux Vector
-----	----------	------------------	-------------

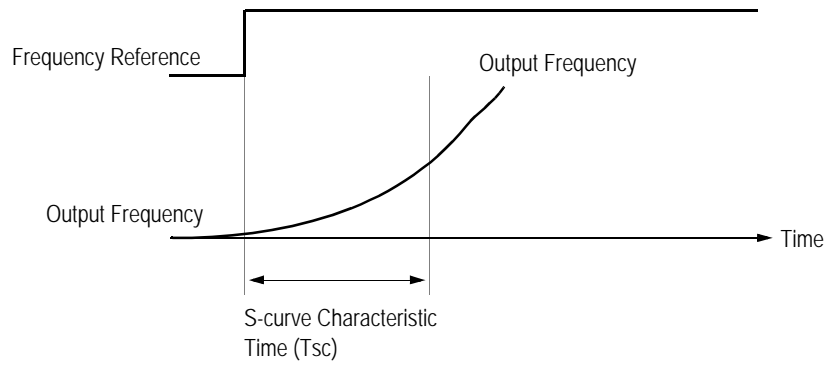

Figure 15 S-curve Characteristic Timing Diagram

The following figure shows FWD/REV run switching during deceleration to stop.

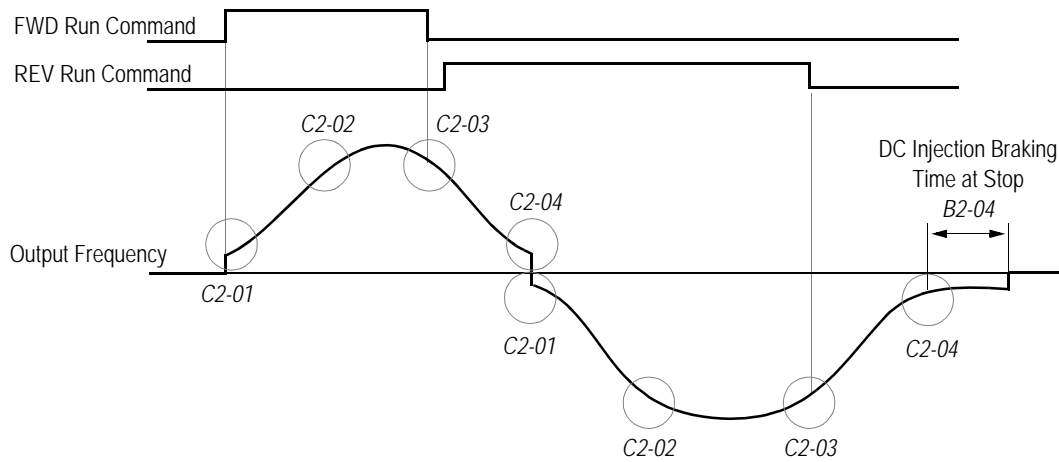

Figure 16 S-curve Characteristics - FWD/REV Operation

Time to accelerate from the minimum frequency to the maximum frequency (total acceleration) = $C1-__ + (C2-01 + C2-02)/2$

V/f	V/f w/PG	Open Loop Vector	Flux Vector
-----	----------	------------------	-------------

C3 Motor Slip Compensation

As the load becomes larger, the motor speed is reduced and motor slip increases. The slip compensation function keeps the motor speed constant even under varying load conditions.

C3-01 Slip Compensation Gain

Slip Comp Gain

B	-	B	B
---	---	---	---

Setting Range: 0.0 to 2.50
 Factory Default: 1.0

This function controls the output frequency in response to the load's torque demand. Increase the set value in one tenth (0.1) increments when operating at low speeds; decrease the set value as the motor speed increases.

During flux vector control, this gain compensates for motor slip causes by changes in temperature. Normally, this setting does not have to be modified.

Note: Default factory setting will be 0.0 when parameter A1-02=0 [V/F mode]. When parameter A1-02=2 [Open Loop Vector] or 3 [Flux Vector] the default factory setting will be 1.0.

C3-02 Slip Compensation Primary Delay Time

Slip Comp Time

A	-	A	-
---	---	---	---

Setting Range: 0 to 10000ms
 Factory Default: 200ms

Adjust the slip compensation delay time when motor speed is unstable or speed response is slow. Increase the set value in 10ms increments when operating at low speeds; decrease the set value as the motor speed increases.

C3-03 Slip Compensation Limit

Slip Comp Limit

A	-	A	-
---	---	---	---

Sets the slip compensation limit as a percentage of motor rated slip (E2-02).

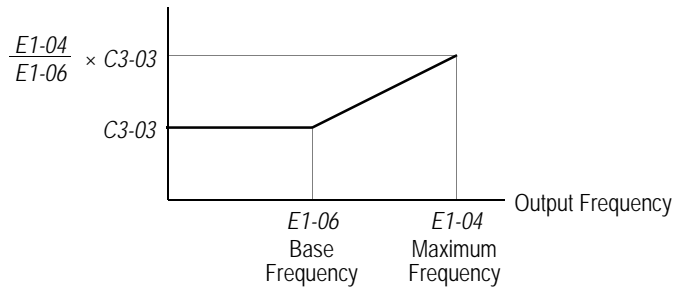

Figure 17 Slip Compensation Limit Adjustment

V/f	V/f w/PG	Open Loop Vector	Flux Vector
-----	----------	------------------	-------------

C3-04 Slip Compensation During Regeneration

Slip Comp Regen

A	-	A	-
---	---	---	---

Setting	Description
0	Slip compensation disabled during regeneration (<i>factory default</i>)
1	Slip compensation enabled during regeneration

C3-05 Flux Calculation Method

Flux Select

-	-	A	-
---	---	---	---

Parameter C3-05 determines if the motor torque characteristic is based on output frequency or motor speed.

Setting	Description
0	Slip Included Motor torque characteristic is based on frequency. (<i>factory default</i>)
1	Slip Excluded Motor torque characteristic is based on motor speed.

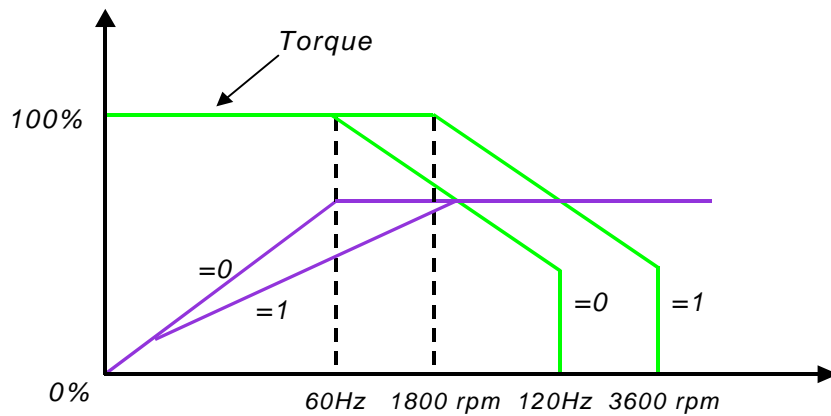

When running the motor only in the constant torque region, leave parameter C3-05 set to 0 for the best performance.

When running the motor in the constant horsepower region, set parameter C3-05 to 1 because the larger flux will result in better motor stability.

V/f	V/f w/PG	Open Loop Vector	Flux Vector
-----	----------	------------------	-------------

C3-06 Output Voltage Limit Operation Selection <1110> **Output V Limit**

-	-	A	A
---	---	---	---

Setting	Description
0	Disabled (<i>factory default</i>) When this parameter is "0" slip compensation will be disabled when the motor is operating above its base speed. The motor voltage will not be reduced above base speed.
1	Enabled Open Loop Vector Mode: When this parameter is set to "1" the motor voltage will be reduced slightly when the motor is operating above 90% base speed. Slip Compensation is enabled. Speed control accuracy is improved. This may prevent speed instabilities due to motor voltage saturation. This setting may improve speed regulation however motor torque/amp will be reduced by up to 10% due to motor voltage reduction above base speed. Flux Vector Mode: Torque linearity is improved.

C4 Torque Compensation

Motor torque can be adjusted by changing the V/f pattern (*E1-03*) or by adjusting the torque compensation gain. For details on setting the V/f pattern, see section *E1, V/f Pattern Adjustment*.

Parameters C4-03, C4-04 and C4-05 are added for the OLV mode to help improve starting/breakaway response. Individual torque compensation settings are possible for forward (C4-03) and reverse (C4-04). The delay time (C4-05) is the time for which the internal torque reference will be increased. This torque compensation is much like inputting an analog torque reference via an analog input.

C4-01 Torque Compensation Gain

Torq Comp Gain

B	B	B	-
---	---	---	---

The motor torque requirement changes according to load conditions. Full-range automatic torque boost adjusts the voltage of the V/f pattern according to the required torque. The VS-616G5 automatically adjusts the voltage during constant-speed operation as well as during acceleration.

The required torque is calculated by the inverter. This ensures triplex operation and power savings.

V/f	V/f w/PG	Open Loop Vector	Flux Vector
-----	----------	------------------	-------------

Output voltage \propto Torque compensation gain \times Required torque

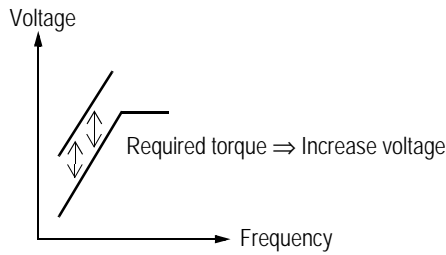

Figure 18 Torque Characteristics

Normally, no adjustment is necessary for torque compensation gain. When more torque is needed, increase the torque compensation gain in one tenth (0.1) increments. When the wiring distance between the inverter and the motor is long, or when the motor generates excessive vibration, decrease the torque compensation gain.

Increasing torque compensation gain increases motor torque, but an excessive increase may cause the following:

- Inverter fault trips due to motor overexcitation
- Motor overheat or excessive vibration

C4-02 Torque Compensation Time Constant

Torq Comp Time

A	A	A	-
---	---	---	---

Setting Range: 0 to 10000ms

Factory Default: 20ms

Increase the torque compensation time constant in 10ms increments when the motor output current is unstable, and decrease this value when speed response is slow.

Note: When A1-02=2 [Open Loop Vector] the factory default setting is 20 ms. When A1-02=1 or 3 [V/F or V/F w/PG] factory default setting is 200 ms.

C4-03 Forward Torque Compensation Value at Start<1110> F TorqCmp @ start

-	-	A	-
---	---	---	---

Setting Range: 0.0 to 200.0%

Factory Default: 0.0

This parameter may improve the motor performance during start. This feature functions only when starting a motor. Torque reference and motor flux can be ramped up quickly to improve speed response during start. A setting of 0.0 disables this feature.

V/f	V/f w/PG	Open Loop Vector	Flux Vector
-----	----------	------------------	-------------

C4-04 Reverse Torque Compensation Value at Start<1110> *R TorqCmp @ start*

-	-	A	-
---	---	---	---

Setting Range: 0.0 to 200.0%

Factory Default: 0.0

This parameter may improve the motor performance during start. This feature functions only when starting a motor. Torque reference and motor flux can be ramped up quickly to improve speed response during start. A setting of 0.0 disables this feature.

C4-05 Torque Compensation Time Constant@Start<1110> *TorqCmp Delay T*

-	-	A	-
---	---	---	---

Setting Range: 0 to 200 ms

Factory Default: 1 ms

This parameter functions with C4-03 and C4-04. This parameter is the time delay that will be applied to the Torque Compensation parameters C4-03 and C4-04. A setting of less than 4 milliseconds (ms) causes this filter to be disabled.

C5 ASR Tuning

The automatic speed regulator (ASR) provides optimum performance during changes in motor speed or load, when speed feedback is provided.

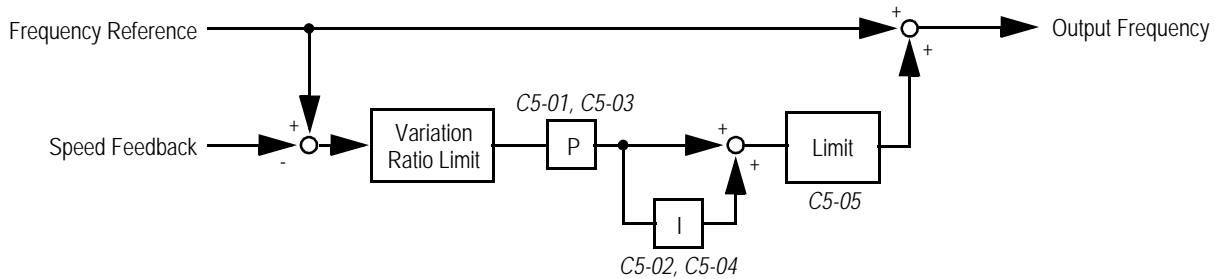

Figure 19 ASR Block Diagram (V/f Control with PG Feedback)

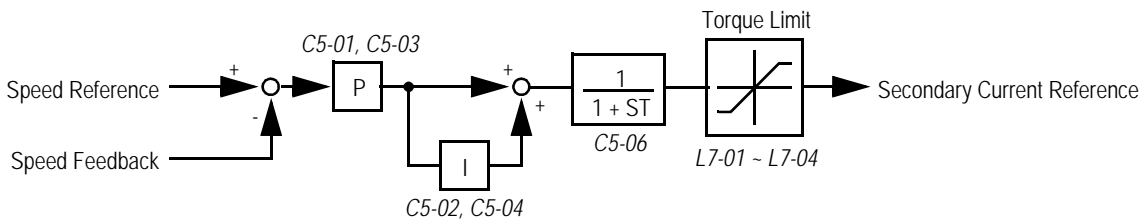

Figure 20 ASR Block Diagram (Flux Vector Control)

V/f	V/f w/PG	Open Loop Vector	Flux Vector
-----	----------	------------------	-------------

C5-01 ASR Proportional Gain 1

ASR P Gain 1

-	B	-	B
---	---	---	---

Setting Range: 0.00 to 300.00
 Factory Default: 20.00

The ASR proportional gain 1 adjusts the speed in response to speed deviation, and softens the effect of changes in load. Speed response increases as the proportional gain is increased. However, the load may become unstable if the ASR proportional gain is set too high.

Note: When parameter A1-02=1 [V/f w/PG] the factory default setting is 0.20. When parameter A1-02=3 the factory default setting is 20.00.

C5-02 ASR Integral Time 1

ASR I Time 1

-	B	-	B
---	---	---	---

Setting Range: 0.000 to 10.000s
 Factory Default: 0.500s

The ASR integral time 1 adjusts the inverter's response time to changes in load. Speed response increases as the integral time is decreased. However, the load may become unstable if the ASR integral time is set too low.

Note: When A1-02=1 [V/f w/PG] the factory default setting is .200. When A1-02=3 factory default setting is 0.500

When A1-02=1 [V/f w/PG] factory default setting is 0.20. When A1-02=3 factory default setting is 20.00.
When A1-02=1 [V/f w/PG] factory default setting is 0.200. When A1-02=3 factory default setting is 0.500
When A1-02=1 [V/f w/PG] factory default setting is 0.02. When A1-02=3 factory default setting is 20.00.

C5-03 ASR Proportional Gain 2

ASR P Gain 2

-	B	-	B
---	---	---	---

Setting Range: 0.00 to 300.00
 Factory Default: 20.00

The ASR proportional gain 2 is an additional proportional gain adjustment that can be enabled by a multi-function contact input (H1-__ = "77").

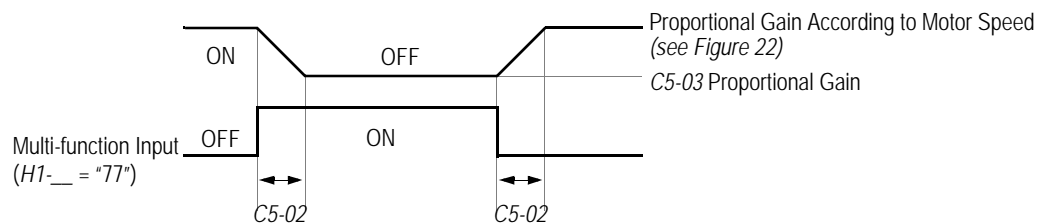

Figure 21 ASR Multi-function Input Timing Diagram

Note: When parameter A1-02=1 [V/f w/PG] factory default setting is .02. When A1-02=3 the factory default setting is 20.00.

Section C: Tuning Parameters
C5 ASR Tuning

V/f	V/f w/PG	Open Loop Vector	Flux Vector
-----	----------	------------------	-------------

C5-04 ASR Integral Time 2	ASR I Time 2	-	B	-	B
---------------------------	--------------	---	---	---	---

Setting Range: 0.000 to 10.000s
 Factory Default: 0.500s

The ASR integral time 2 is an additional integral time adjustment.

C5-05 ASR Limit	ASR Limit	-	A	-	-
-----------------	-----------	---	---	---	---

Sets ASR frequency compensation limit as a percentage of maximum output frequency (E1-04). This function is enabled when V/f control with PG feedback is selected as the control method (A1-02).

C5-06 ASR Output Primary Delay Time	ASR Delay Time	-	-	-	A
-------------------------------------	----------------	---	---	---	---

Setting Range: 0.000 to 0.500s
 Factory Default: 0.004s

Mechanical backlash in an application causes secondary current (I₂) reference variations in the motor's rotor. This condition can prevent the adjustment of ASR parameters. The output delay time constant is used to control these secondary current (I₂) reference variations.

C5-07 ASR Switching Frequency Level	ASR Gain SW Freq	-	-	-	A
-------------------------------------	------------------	---	---	---	---

Setting Range: 0.0 to 400.0Hz
 Factory Default: 0.0Hz

Sets frequency to change ASR proportional gain and integral time constant in units of 0.1Hz when flux vector control is selected.

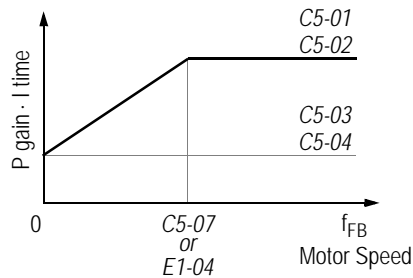

$$f_{FB} = \frac{P \cdot N}{120}$$

where:
 P = Number of Motor Poles
 N = Motor RPM

* When C5-07 = "0", proportional gain 1 (C5-01) and integral time 1 (C5-02) are selected.

Figure 22 ASR Switching Frequency Level

Notes:

1. When C5-07 = "0", proportional gain 1 (C5-01) and integral time 1 (C5-02) are selected.
2. During V/f control with PG feedback (A1-02 = "1"), the frequency switching level becomes the maximum output frequency (E1-04).

V/f	V/f w/PG	Open Loop Vector	Flux Vector
-----	----------	------------------	-------------

C5-08 ASR Integral Limit

ASR I Limit

-	-	-	A
---	---	---	---

Setting Range: 0 to 400%
 Factory Default: 400%

Parameter C5-08 adjusts the amount of Integral control of the automatic speed regulator in the Closed Loop Flux Vector control mode. Setting parameter C5-08 to zero will make the ASR control proportional. Setting C5-08 to 400% will make the ASR control proportional and integral.

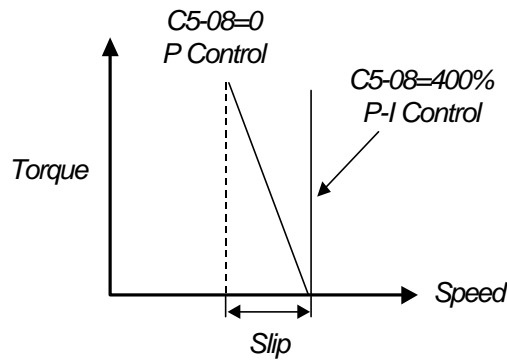

C6 Carrier Frequency

This function sets the inverter output transistor switching frequency (carrier frequency). Increase the carrier frequency to reduce motor noise and decrease it to reduce leakage current.

C6-01 Carrier Frequency Upper Limit

CarrierFreq Max

C6-02 Carrier Frequency Lower Limit

CarrierFreq Min

B	B	B	B
A	A	-	-

Setting Range: 0.4 to 15.0kHz
 Factory Default: 15.0Hz*

For constant carrier frequency operation, set the gain (C6-03) to “0”, and set the upper limit (C6-01) and lower limit (C6-02) to the same value.

* Factory defaults vary depending on drive rating. See the following table for more details:

Carrier Frequency Factory Defaults

Model CIMR- G5U	Upper Limit C6-01 Setting	Lower Limit C6-02 Setting	Gain C6-03 Setting	Model CIMR- G5U	Upper Limit C6-01 Setting	Lower Limit C6-02 Setting	Gain C6-03 Setting
230							
20P4	15.0	15.0	0	2015	15.0	15.0	0
20P7	15.0	15.0	0	2018	15.0	15.0	0
21P5	15.0	15.0	0	2022	10.0	10.0	0
22P2	15.0	15.0	0	2030	10.0	10.0	0
23P7	15.0	15.0	0	2037	10.0	10.0	0
25P5	15.0	15.0	0	2045	10.0	10.0	0
27P5	15.0	15.0	0	2055	10.0	10.0	0
2011	15.0	15.0	0	2075	10.0	10.0	0
-	-	-	-	2090	2.0	2.0	0
-	-	-	-	2185	2.0	2.0	0
460							
40P4	15.0	15.0	0	4022	8.0	8.0	0
40P7	15.0	15.0	0	4030	8.0	8.0	0
41P5	15.0	15.0	0	4037	6.0	6.0	0
42P2	15.0	15.0	0	4045	6.0	6.0	0
43P7	15.0	15.0	0	4055	6.0	6.0	0
44P0	15.0	15.0	0	4075	6.0	6.0	0
45P5	15.0	15.0	0	4090	5.0	5.0	0
47P5	12.5	12.5	0	4110	5.0	5.0	0
4011	12.5	12.5	0	4132	5.0	5.0	0
4015	10.0	10.0	0	4160	5.0	5.0	0
4018	10.0	10.0	0	4185	2.0	2.0	0
-	-	-	-	4220	2.0	2.0	0
-	-	-	-	4300	2.0	2.0	0
575							
51P5	10.0	10.0	0	5030	10.0	10.0	0
52P2	10.0	10.0	0	5037	10.0	10.0	0
53P7	10.0	10.0	0	5045	10.0	10.0	0
55P5	10.0	10.0	0	5055	8.0	8.0	0
57P5	10.0	10.0	0	5075	2.0	1.0	36
5011	10.0	10.0	0	5090	2.0	1.0	36
5015	10.0	10.0	0	5110	2.0	1.0	36
5018	10.0	10.0	0	5160	2.0	1.0	36
5022	10.0	10.0	0				

V/f	V/f w/PG	Open Loop Vector	Flux Vector
-----	----------	------------------	-------------

C6-03 Carrier Proportional Gain

CarrierFreq Gain

A	A	-	-
---	---	---	---

Setting Range: 0 to 99
 Factory Default: 0

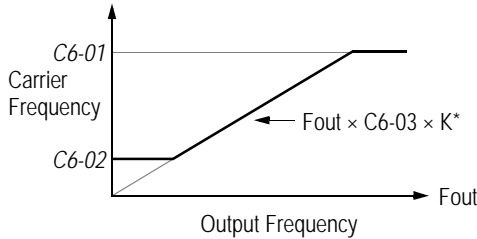

* K varies depending on the carrier frequency upper limit (C6-01):

$C6-01 > 10.0\text{kHz}$	K = 3
$10.0\text{kHz} > C6-01 > 5.0\text{kHz}$	K = 2
$C6-01 < 5.0\text{kHz}$	K = 1

Figure 23 Carrier Frequency Setting

Note: An OPE11 fault occurs if either of the following conditions is present:

1. $C6-03 > 6\text{kHz}$ and $C6-02 > C6-01$
2. $C6-01 > 5\text{kHz}$ and $C6-02 \leq 5\text{kHz}$

C7 Hunting Prevention

Occasionally, in an application, resonance between the internal control system and the mechanical system causes current instability. This instability is called hunting, and may cause the machine to vibrate at lower speeds (up to 30Hz). The hunting prevention function monitors the motor flux and uses a special control circuit to “smooth out” any peaks in the output current waveform.

C7-01 Hunting Prevention Selection

Hunt Prev Select

A	A	-	-
---	---	---	---

Enables the hunting prevention function in V/f control mode.

Setting	Description
0	Hunting prevention is disabled.
1	Hunting prevention is enabled (<i>factory default</i>).

C7-02 Hunting Prevention Gain

Hunt Prev Gain

A	A	-	-
---	---	---	---

Setting Range: 0.00 to 2.50
 Factory Default: 1.00

Sets hunting prevention gain in units of 0.01. When hunting is present while driving a light load, increase the set value in one tenth (0.1) increments. When the motor vibrates or stalls while driving a heavy load, decrease the set value.

Vf	Vf w/PG	Open Loop Vector	Flux Vector
----	---------	------------------	-------------

C8 Factory Tuning

This section describes parameters not normally accessed by the user, but which may require adjustment.

C8-08 Automatic Frequency Regulator Adjustment AFR Gain

-	-	A	-
---	---	---	---

Setting Range: 0.00 to 10.00
 Factory Default: 1.00

Sets AFR gain in units of 0.01. When hunting is present during open loop vector control, decrease the set value in one tenth (0.1) increments. If the speed or torque response is slow, increase the set value.

C8-09 Automatic Frequency Regulator Time Constant AFR Time

-	-	A	-
---	---	---	---

Setting Range: 0 to 2000 milliseconds
 Factory Default: 50 milliseconds

Parameter C8-09 sets the AFR (automatic frequency regulator) time. Adjusting C8-09 will increase or decrease the AFR frequency response, when the load changes.
 If the motor is unstable, increase the set value.
 If the speed response is slow, decrease the set value.

C8-30 Carrier Frequency Selection During Auto-tuning Carrier in Tune

-	-	A	A
---	---	---	---

During normal auto-tuning, the inverter is tuned while running at a carrier frequency of 2kHz. This parameter allows the user to specify the inverter carrier frequency during auto-tuning. Adjustment may be necessary when using a spindle motor with low inductance.

Setting	Description
0	Carrier frequency during auto-tuning is 2kHz (<i>factory default</i>).
1	Carrier frequency during auto-tuning is set by C6-01.
2	Carrier frequency is 5kHz. Except for 185-300 kW which is 2.5 kHz

V/f	V/f w/PG	Open Loop Vector	Flux Vector
-----	----------	------------------	-------------

D Reference Parameters

D1 Preset References

<i>D1-01 Preset Frequency Reference 1</i>	<i>Reference 1</i>
<i>D1-02 Preset Frequency Reference 2</i>	<i>Reference 2</i>
<i>D1-03 Preset Frequency Reference 3</i>	<i>Reference 3</i>
<i>D1-04 Preset Frequency Reference 4</i>	<i>Reference 4</i>
<i>D1-05 Preset Frequency Reference 5</i>	<i>Reference 5</i>
<i>D1-06 Preset Frequency Reference 6</i>	<i>Reference 6</i>
<i>D1-07 Preset Frequency Reference 7</i>	<i>Reference 7</i>
<i>D1-08 Preset Frequency Reference 8</i>	<i>Reference 8</i>

Q	Q	Q	Q
Q	Q	Q	Q
Q	Q	Q	Q
Q	Q	Q	Q
B	B	B	B
B	B	B	B
B	B	B	B
B	B	B	B

Setting Range: 0.0 to 400.0Hz
 Factory Default: 0.0Hz

Up to 9 preset speed references (including jog) can be set through multi-function contact input function selections. When using the multi-step speed references, set the reference selection (*B1-01*) to "0", and set terminal 16 selection (*H3-05*) to "1F". See the following table for programming preset speed references.

Terminal 5 <i>H1-03 = "3"</i>	Terminal 6 <i>H1-04 = "4"</i>	Terminal 7 <i>H1-05 = "5"</i>	Terminal 8 <i>H1-06 = "6"</i>	Speed Reference
Open	Open	Open	Open	Speed Reference 1 - Set Reference Source (<i>B1-01</i>) to "0".
Closed	Open	Open	Open	Speed Reference 2 - Set Terminal 16 Selection (<i>H3-05</i>) to "1F".
Open	Closed	Open	Open	Speed Reference 3
Closed	Closed	Open	Open	Speed Reference 4
Open	Open	Closed	Open	Speed Reference 5
Closed	Open	Closed	Open	Speed Reference 6
Open	Closed	Closed	Open	Speed Reference 7
Closed	Closed	Closed	Open	Speed Reference 8
Closed	Closed	Closed	Closed	Jog Speed Reference

V _f	V _f w/PG	Open Loop Vector	Flux Vector
----------------	---------------------	------------------	-------------

D1-09 Jog Frequency Reference

JOG Reference

Q	Q	Q	Q
---	---	---	---

Setting Range: 0.0 to 400.0Hz
 Factory Default: 0.0Hz

The jog frequency reference can be set in this parameter. Depress the JOG key on the digital operator, or close terminal 7, to use this function. The jog command always has priority over other reference commands. When using the multi-step speed references, change the jog command from terminal 7 to terminal 8 (*H1-06* = "6").

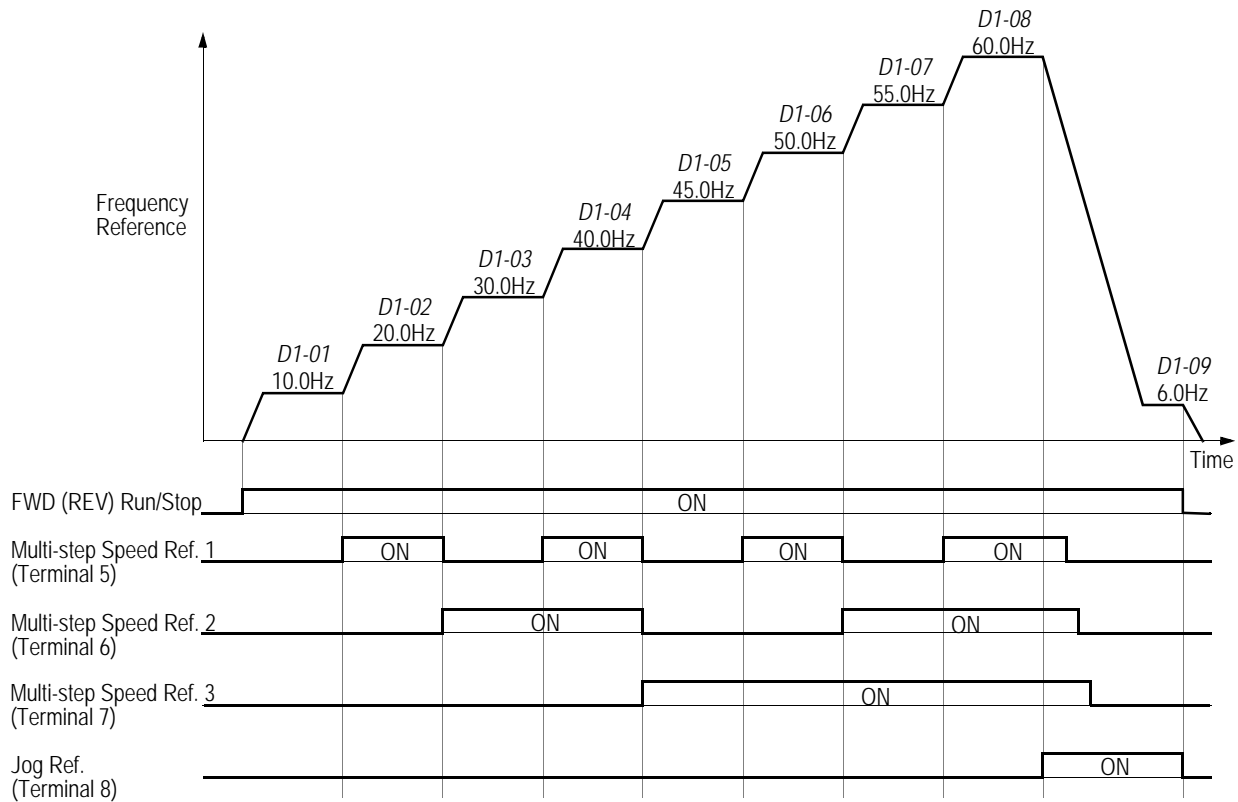

Figure 24 Multi-step Speed Operation - Timing Diagram

Note: Setting units for *D1-01* to *D1-09* are dependent upon the setting of digital operator display mode (*O1-03*). Possible setting units include Hz, percentage, RPM or engineering units. See section **O1, Monitor Selection**, on page 120 for more details.

V/f	V/f w/PG	Open Loop Vector	Flux Vector
-----	----------	------------------	-------------

D2 Reference Limits

D2-01 Frequency Reference Upper Limit

Ref Upper Limit

B	B	B	B
---	---	---	---

Setting Range: 0.0 to 110.0%
 Factory Default: 100.0%

The frequency reference upper limit is set as a percentage of the maximum output frequency (E1-04) in increments of 1%.

D2-02 Frequency Reference Lower Limit

Ref Lower Limit

B	B	B	B
---	---	---	---

Setting Range: 0.0 to 109.0%
 Factory Default: 100.0%

The frequency reference lower limit is set as a percentage of the maximum output frequency (E1-04) in increments of 1%. When a run command is input and the frequency reference is less than the lower limit, operation continues at the frequency reference lower limit. However, when the lower limit is set to less than the minimum output frequency (E1-09), operation discontinues.

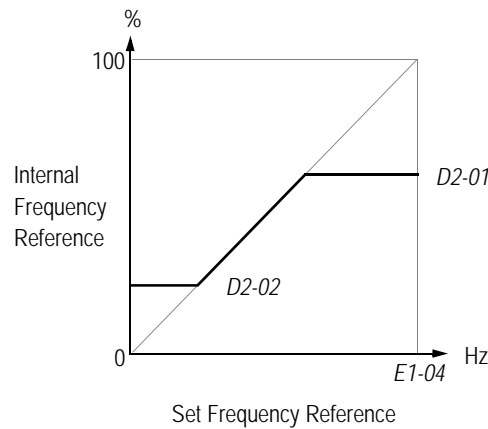

Figure 25 Setting Frequency Upper and Lower Limits

D3 Jump Frequencies

D3-01 Jump Frequency Reference 1

Jump Freq 1

D3-02 Jump Frequency Reference 2

Jump Freq 2

D3-03 Jump Frequency Reference 3

Jump Freq 3

D3-04 Jump Frequency Reference Bandwidth

Jump Bandwidth

B	B	B	B
B	B	B	B
B	B	B	B
B	B	B	B

This function allows the prohibition or “jumping” of critical frequencies so that the motor can operate without resonant vibrations caused by some machine systems. This function is also used for dead-band control. Setting the value to 0.0Hz disables this function.

V/f	V/f w/Pg	Open Loop Vector	Flux Vector
-----	----------	------------------	-------------

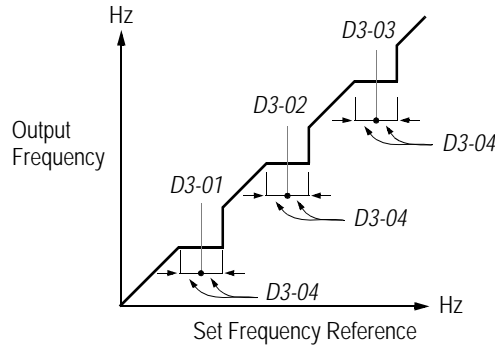

Figure 26 Jump Frequencies

D4 Sequence

D4-01 Hold Reference Memory Selection

MOP Ref Memory

A	A	A	A
---	---	---	---

Selects whether the held frequency during motor operated potentiometer (MOP) simulation operation is stored when operation is stopped (when power is removed or when the run command is removed).

Setting	Description
0	Held frequency during MOP operation not retained. If a stop command is given or if power is removed, the frequency reference is reset to 0Hz. If the inverter is still decelerating when the run command is restored, operation resumes at the frequency reference which the inverter has ramped down to (<i>factory default</i>).
1	Held frequency during MOP operation is retained. If a stop command is given, or if power is removed, operation resumes at the held frequency reference when run command is restored.

Note: MOP operation is set using the multi-function contact input function selections (*H1-01* to *H1-06*, setting = “10” and “11”). See section **H1, Digital Inputs**, on page 76 for more information.

D4-02 Trim Control Level

Trim Control Lvl

A	A	A	A
---	---	---	---

Setting Range: 0 to 100%
 Factory Default: 10%

Sets the motor operated pot or “trim” control level as a percentage of maximum output frequency in units of 1%. When trim control increase and decrease are selected as multi-function contact input functions (setting: *H1-__* = “1C” and “1D”, respectively), the trim control level is added to or subtracted from the analog frequency reference, when each respective contact closes. This is useful in applications such as winders and unwinders, where speed compensation may be needed.

D5 Torque Control

V/f	V/f w/PG	Open Loop Vector	Flux Vector
-----	----------	------------------	-------------

D5-01 Torque Control Selection

Torq Control Sel

-	-	-	A
---	---	---	---

Selects between speed and torque control during flux vector operation (*A1-03* = “3”).

Setting	Description
0	Speed control enabled with torque limit (<i>factory default</i>)
1	Torque control enabled with speed limit

Speed/torque control selection can also be made by using a multi-function contact input function selection (*H1-__* = “71”).

D5-02 Torque Limit Primary Delay Time

Torq Ref Filter

-	-	-	A
---	---	---	---

Setting Range: 0 to 1000ms

Factory Default: 0ms

Sets delay time constant for torque reference input in the torque control mode, in units of 1ms.

D5-03 Speed Limit Input Selection

Speed Limit Sel

-	-	-	A
---	---	---	---

Sets speed limit selection in the torque control mode.

Setting	Description
1	Speed limit is the analog speed reference set by terminal 13 or 14 (<i>factory default</i>).
2	Speed limit is the reference set by <i>B1-01</i> .

D5-04 Speed Limit Value

Speed Lmt Value

-	-	-	A
---	---	---	---

Setting Range: -120 to 120%

Factory Default: 0%

Sets the speed limit value in the torque control mode as a percentage of the maximum output frequency, when *D5-03* = “2”.

V/f	V/f w/PG	Open Loop Vector	Flux Vector
-----	----------	------------------	-------------

D5-05 Speed Limit Bias

Speed Lmt Bias

-	-	-	A
---	---	---	---

Setting Range: 0 to 120%
 Factory Default: 10%

Sets the speed limit bias value in the torque control mode as a percentage of the maximum output frequency.

D5-06 Reference Delay Timer

Ref Hold Time

-	-	-	A
---	---	---	---

Setting Range: 0 to 1000ms
 Factory Default: 0ms

Sets delay time from when the speed/torque control selection is made to when the control mode is actually changed, in units of 1ms.

Torque Control Operation

To select torque control, set torque selection (D5-01) to “1”, or close the multi-function contact input set to speed/torque control (H1-__ = “71”) and set terminal 16 function selection to torque reference (H3-05 = “13”).

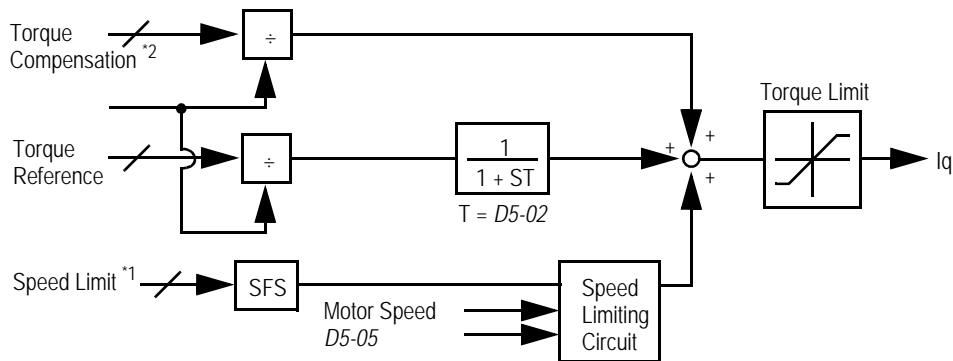

Figure 27 Torque Control Block Diagram

- *1: When speed limit selection (D5-03) is set to “1”, the master frequency reference input from terminal 13 or 14 becomes the speed limit; when speed limit selection (D5-03) is set to “2”, the set value of D5-04 becomes the speed limit.
- *2: When terminal 14 function selection is set to torque compensation (H3-09 = “14”), terminal 14 set value can be used as the torque compensation value.

When torque reference > 0 and speed limit > 0 (winder application sequence), the following sequence is activated:

- When $[-1 \times \text{speed limit bias } (D5-05)] < \text{motor speed} < [\text{speed limit} + D5-05]$, torque control is activated using the set torque reference.
- When $\text{motor speed} > [\text{speed limit} + D5-05]$, torque control is activated using the set torque reference.
- When $\text{motor speed} < [-1 \times D5-05]$, the speed limiting circuit outputs a positive torque reference to prevent the motor speed from increasing in the reverse direction.

Therefore, when torque reference > 0 and speed limit > 0 , the torque control range is:

$$[-1 \times D5-05] < \text{motor speed} < [\text{speed limit} + D5-05]$$

Refer to the following table for more details on the relationship between torque reference, speed limit and motor speed.

		Winder Control		Unwinder Control	
Configuration					
Direction of Motor Rotation		Forward	Reverse	Forward	Reverse
Reference Polarity	Torque Reference (TREF)	+	-	-	+
	Speed Limit (NLIM)	+	-	+	-
Torque Profile					

Speed/Torque Control Switching

When the VS-616G5 is set up for flux vector control ($A1-03 = "3"$), speed control or torque control can be selected “on the fly” by using the multi-function input speed/torque control selection command ($H1-__ = "71"$).

Terminal No.	Parameter No.	Setting	Description
8	$H1-06$	71	Speed/torque control selection
13	$B1-01$ $D5-03$	1	Frequency reference selection (terminals 13, 14) Speed limit selection (terminals 13, 14)
16	$H3-05$	13	Torque reference/speed limit

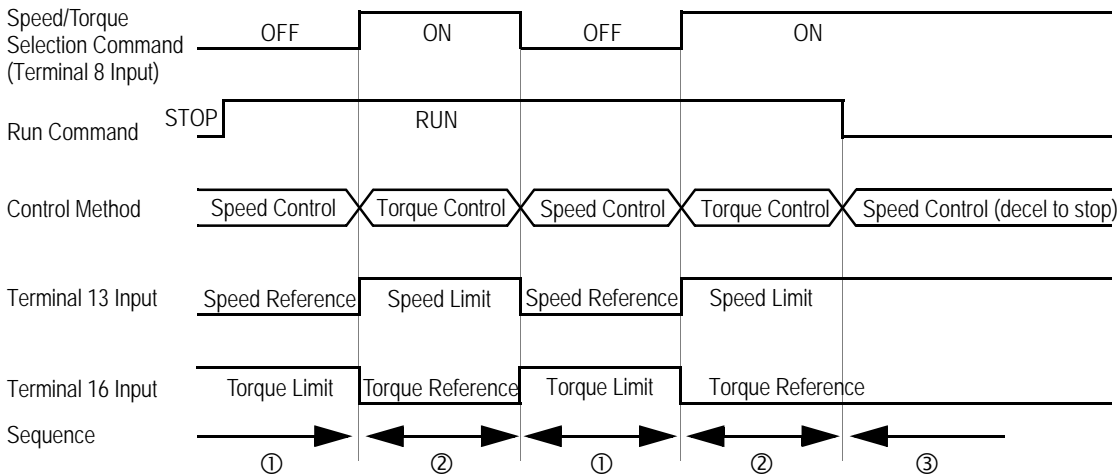

Figure 28 Speed/Torque Control Selection Timing Diagram

Sequence Description

- ① When the speed/torque control selection contact is OFF, speed control is activated.
 - Speed reference during speed control depends on the frequency reference selection ($B1-01$) setting. To use terminal 13 or 14 as the master frequency reference, set $B1-01$ to “1”.
 - Torque limit during speed control is the smaller of the absolute value of terminal 16 torque limit, or the values set in the torque limit parameters ($L7-01$ to $L7-04$).
 - When a stop command is given during speed control, speed control is maintained and the smaller of the absolute value of terminal 16 torque limit, or the values set in the torque limit parameters ($L7-01$ to $L7-04$), is used as the torque limit. Then the motor decelerates to stop.
- ② When the speed/torque control selection contact is ON, torque control is activated.
 - Speed limit during torque control is the master frequency reference at terminal 13 or 14 when speed limit selection ($D5-03$) is set to “1”, and is the speed limit value ($D5-04$) when $D5-03 = "2"$, regardless of the frequency reference selection ($B1-01$) setting.
 - During torque control, the terminal 16 analog input value becomes the torque reference.

V/f	V/f w/PG	Open Loop Vector	Flux Vector
-----	----------	------------------	-------------

- ③ By giving a stop command during torque control, operation changes to speed control automatically, and the motor decelerates to stop. The torque limit during deceleration to stop becomes the values set in the torque limit parameters (*L7-01* to *L7-04*).

Note: The control mode actually changes after the speed/torque control selection command changes *and* after the reference delay timer (*D5-06*) elapses. The terminal 13 speed reference/speed limit and the terminal 16 torque limit/torque reference are stored in the inverter until the time set to *D5-06* elapses.

E Motor Parameters
E1 V/f Pattern

E1-01 Input Voltage *Input Voltage*

0	0	0	0
---	---	---	---

Setting Range: 155 to 255V (230V class), 310 to 510V (460V class) 445 to 733 (575V class) <1110>
 Factory Default: 230V, 460V, 575V <1110>

Sets the inverter input voltage in units of 1V.

E1-02 Motor Selection *Motor Selection*

0	0	0	0
---	---	---	---

Select between fan-cooled, blower-cooled and vector/inverter duty motor types with this parameter.

Setting	Description
0	Fan-cooled motor characteristics (<i>factory default</i>)
1	Blower-cooled or TENV motor characteristics This setting allows 120% motor current at and above 5.6 Hz continuously, and allows 100% motor current at 0 Hz continuously (w/ linear in between).
2	Vector/inverter duty motor <1110> This setting allows 120% motor current at all frequencies.

E1-03 V/f Pattern Selection *V/f Selection*

0	0	0	0
---	---	---	---

Choose a preset V/f pattern for operation in V/f modes only. It may be necessary to change the V/f pattern when using a high-speed motor, or when special torque adjustment is required in the application.

Set values 0 to E: preset V/f pattern can be selected
F: custom V/f pattern can be set (*factory default*)

Preset V/f patterns are automatically scaled by the input voltage value set in parameter *E1-01*. Set the V/f pattern according to the applications described in the table on the following page:

V/f	V/f w/PG	Open Loop Vector	Flux Vector
-----	----------	------------------	-------------

Preset V/f Patterns

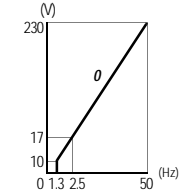
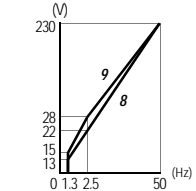
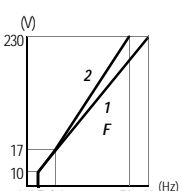
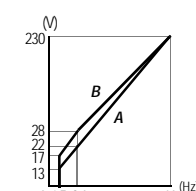
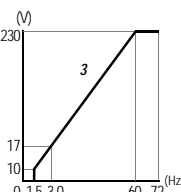
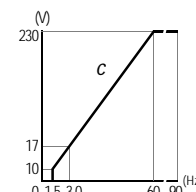
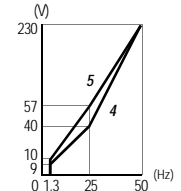
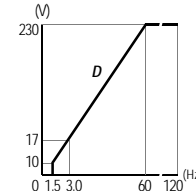
Specifications		E1-03	V/f Pattern *1	Specifications		E1-03	V/f Pattern *1
General-purpose	50Hz	0		High Starting Torque *2	50Hz	8	
	60Hz Saturation	1 F			50Hz	9	
	50Hz Saturation	2			60Hz	A	
	72Hz	3			60Hz	B	
Variable Torque	50Hz	Variable Torque 1		High Speed Operation	90Hz	C	
		Variable Torque 2			5	120Hz	D
	60Hz	Variable Torque 1	6		180Hz		
		Variable Torque 2	7				

Notes:

- 1 The following conditions must be considered when selecting a V/f pattern:
 - The voltage and frequency characteristics of the motor.
 - The maximum speed of the motor.
- 2 Select a high starting torque V/f pattern only under the following conditions:
 - The wiring distance is long - 492 ft. (150m) and above.
 - Large voltage drop at start-up.
 - AC reactor is connected to the inverter's input or output.
- 3 Voltage in preset patterns is doubled for 460V class inverters. The 575V patterns are 2.5 times the 230V patterns.

V/f	V/f w/PG	Open Loop Vector	Flux Vector
-----	----------	------------------	-------------

Custom V/f Pattern

Set up a custom V/f pattern by setting parameter *E1-03* to “F”, and then setting the values in parameters *E1-04* to *E1-13*.

- E1-04* Maximum Frequency
- E1-05* Maximum Voltage
- E1-06* Motor Base Frequency
- E1-07* Middle Output Frequency A
- E1-08* Middle Output Voltage A
- E1-09* Minimum Output Frequency
- E1-10* Minimum Output Voltage
- E1-11* Middle Output Frequency B
- E1-12* Middle Output Voltage B
- E1-13* Motor Base Voltage

- Max Frequency
- Max Voltage
- Base Frequency
- Mid Frequency A
- Mid Voltage A
- Min Frequency
- Min Voltage
- Mid Frequency B
- Mid Voltage B
- Base Voltage

Q	Q	Q	Q
Q	Q	Q	Q
Q	Q	Q	Q
Q	Q	A	—
Q	Q	A	—
Q	Q	Q	A
Q	Q	A	—
A	A	A	A
A	A	A	A
A	A	Q	Q

Be sure to satisfy the following conditions for setting parameters *E1-04* to *E1-13*:
 $E1-09 \leq E1-07 \leq E1-06 \leq E1-11 \leq E1-04$

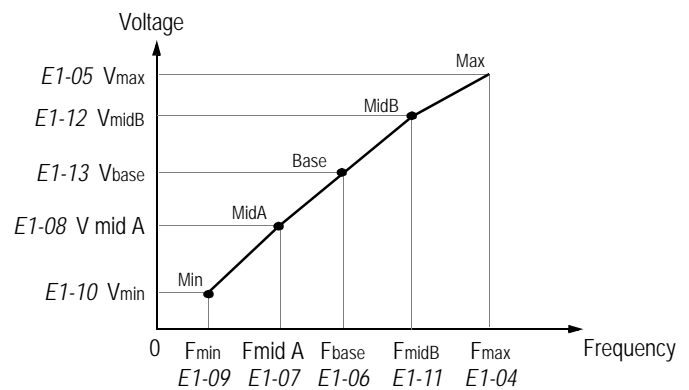

Figure 28 Custom V/f Pattern Setting

* For 460V class units, the value is twice that of 230V class units. For 575V class units the value is 2.5 times the 230V value.

Increasing the voltage in the V/f pattern increases motor torque. However, when setting a custom V/f pattern, increase the voltage gradually while monitoring the motor current, to prevent:

- Inverter fault trips as a result of motor overexcitation
- Motor overheat or excessive vibration

V/f	V/f w/PG	Open Loop Vector	Flux Vector
-----	----------	------------------	-------------

V/F Pattern for Inverter Capacity 0.4 ~ 1.5kW for 200V Class

Parameter No.	Name	Unit	Factory Setting							
			0	1	2	3	4	5	6	7
E1-03	V/f Pattern Selection	—	0	1	2	3	4	5	6	7
E1-04	Max. Output Frequency	Hz	50.0	60.0	60.0	72.0	50.0	50.0	60.0	60.0
E1-05	Max. Voltage	V	230.0	230.0	230.0	230.0	230.0	230.0	230.0	230.0
E1-06	Max. Voltage Frequency	Hz	50.0	60.0	50.0	60.0	50.0	50.0	60.0	60.0
E1-07	Mid. Output Frequency	V	2.5	3.0	3.0	3.0	25.0	25.0	30.0	30.0
E1-08	Mid. Output Frequency Voltage	V	17.2	17.2	17.2	17.2	40.2	57.5	40.2	57.5
E1-09	Min. Output Frequency	Hz	1.3	1.5	1.5	1.5	1.3	1.3	1.5	1.5
E1-10	Min. Output Frequency Voltage	V	10.3	10.3	10.3	10.3	9.2	10.3	9.2	10.3

For 460V class units, the value is twice that of 230V class units. For 575V class units the value is 2.5 times the 230V value.

Inverter Capacity 0.4 ~ 1.5kW for 200V Class (Continued)

Parameter No.	Name	Unit	Factory Setting							
			8	9	A	B	C	D	E	F
E1-03	V/f Pattern Selection	—	8	9	A	B	C	D	E	F
E1-04	Max. Output Frequency	Hz	50.0	50.0	60.0	60.0	90.0	120.0	180.0	60.0
E1-05	Max. Voltage	V	230.0	230.0	230.0	230.0	230.0	230.0	230.0	230.0
E1-06	Max. Voltage Frequency	Hz	50.0	50.0	60.0	60.0	60.0	60.0	60.0	60.0
E1-07	Mid. Output Frequency	V	2.5	2.5	3.0	3.0	3.0	3.0	3.0	3.0
E1-08	Mid. Output Frequency Voltage	V	21.8	27.6	21.8	27.6	17.2	17.2	17.2	17.2
E1-09	Min. Output Frequency	Hz	1.3	1.3	1.5	1.5	1.5	1.5	1.5	1.5
E1-10	Min. Output Frequency Voltage	V	12.6	14.9	12.6	17.2	10.3	10.3	10.3	10.3

For 460V class units, the value is twice that of 230V class units. For 575V class units the value is 2.5 times the 230V value.

V/f	V/f w/PG	Open Loop Vector	Flux Vector
-----	----------	------------------	-------------

V/F Patterns for Inverter Capacity 2.2 ~ 45kW for 200V Class

Parameter No.	Name	Unit	Factory Setting							
			0	1	2	3	4	5	6	7
E1-03	V/f Pattern Selection	—	0	1	2	3	4	5	6	7
E1-04	Max. Output Frequency	Hz	50.0	60.0	60.0	72.0	50.0	50.0	60.0	60.0
E1-05	Max. Voltage	V	230.0	230.0	230.0	230.0	230.0	230.0	230.0	230.0
E1-06	Max. Voltage Frequency	Hz	50.0	60.0	50.0	60.0	50.0	50.0	60.0	60.0
E1-07	Mid. Output Frequency	V	2.5	3.0	3.0	3.0	25.0	25.0	30.0	30.0
E1-08	Mid. Output Frequency Voltage	V	16.1	16.1	16.1	16.1	40.2	57.5	40.2	57.5
E1-09	Min. Output Frequency	Hz	1.3	1.5	1.5	1.5	1.3	1.3	1.5	1.5
E1-10	Min. Output Frequency Voltage	V	8.0	8.0	8.0	8.0	6.9	8.0	6.9	8.0

For 460V class units, the value is twice that of 230V class units. For 575V class units the value is 2.5 times the 230V value.

V/F Patterns for Inverter Capacity 2.2 ~ 45kW for 200V Class (Continued)

Parameter No.	Name	Unit	Factory Setting							
			8	9	A	B	C	D	E	F
E1-03	V/f Pattern Selection	—	8	9	A	B	C	D	E	F
E1-04	Max. Output Frequency	Hz	50.0	50.0	60.0	60.0	90.0	120.0	180.0	60.0
E1-05	Max. Voltage	V	230.0	230.0	230.0	230.0	230.0	230.0	230.0	230.0
E1-06	Max. Voltage Frequency	Hz	50.0	50.0	60.0	60.0	60.0	60.0	60.0	60.0
E1-07	Mid. Output Frequency	V	2.5	2.5	3.0	3.0	3.0	3.0	3.0	3.0
E1-08	Mid. Output Frequency Voltage	V	20.7	26.4	20.7	26.4	16.1	16.1	16.1	16.1
E1-09	Min. Output Frequency	Hz	1.3	1.3	1.5	1.5	1.5	1.5	1.5	1.5
E1-10	Min. Output Frequency Voltage	V	10.3	12.6	10.3	14.9	8.0	8.0	8.0	8.0

For 460V class units, the value is twice that of 230V class units. For 575V class units the value is 2.5 times the 230V value.

V/f	V/f w/PG	Open Loop Vector	Flux Vector
-----	----------	------------------	-------------

V/F Patterns for Inverter Capacity 55 ~ 300kW for 200V Class

Parameter	Name	Unit	Factory Setting							
			0	1	2	3	4	5	6	7
E1-03	V/f Pattern Selection	–	0	1	2	3	4	5	6	7
E1-04	Max. Output Frequency	Hz	50.0<21>	60.0	60.0	72.0<21>	50.0<21>	50.0<21>	60.0	60.0
E1-05	Max. Voltage	V	230.0	230.0	230.0	230.0	230.0	230.0	230.0	230.0
E1-06	Max. Voltage Frequency	Hz	50.0<21>	60.0	50.0<21>	60.0	50.0<21>	50.0<21>	60.0	60.0
E1-07	Mid. Output Frequency	V	2.5<21>	3.0	3.0	3.0	25.0<21>	25.0<21>	30.0	30.0
E1-08	Mid. Output Frequency Voltage	V	13.8<21>	13.8<21>	13.8<21>	13.8<21>	40.2<21>	57.5<21>	40.2<21>	57.5<21>
E1-09	Min. Output Frequency	Hz	1.3<21>	1.5	1.5	1.5	1.3<21>	1.3<21>	1.5	1.5
E1-10	Min. Output Frequency Voltage	V	6.9	6.9	6.9	6.9	5.7<21>	6.9	5.7<21>	6.9

For 460V class units, the value is twice that of 230V class units. For 575V class units the value is 2.5 times the 230V value.

V/F Patterns for Inverter Capacity 55 ~ 300kW for 200V Class (Continued)

Parameter	Name	Unit	Factory Setting							
			8	9	A	B	C	D	E	F
E1-03	V/f Pattern Selection	–	8	9	A	B	C	D	E	F
E1-04	Max. Output Frequency	Hz	50.0<21>	50.0<21>	60.0	60.0	90.0<21>	120.0<21>	180.0<21>	60.0
E1-05	Max. Voltage	V	230.0	230.0	230.0	230.0	230.0	230.0	230.0	230.0
E1-06	Max. Voltage Frequency	Hz	50.0<21>	50.0<21>	60.0	60.0	60.0	60.0	60.0	60.0
E1-07	Mid. Output Frequency	V	2.5<21>	2.5<21>	3.0	3.0	3.0	3.0	3.0	3.0
E1-08	Mid. Output Frequency Voltage	V	17.2<21>	23.0<21>	17.2<21>	23.0<21>	13.8<21>	13.8<21>	13.8<21>	13.8<21>
E1-09	Min. Output Frequency	Hz	1.3<21>	1.3<21>	1.5	1.5	1.5	1.5	1.5	1.5
E1-10	Min. Output Frequency Voltage	V	8.0<21>	10.3<21>	8.0<21>	12.6<21>	6.9	6.9	6.9	6.9

For 460V class units, the value is twice that of 230V class units. For 575V class units the value is 2.5 times the 230V value.

V/f	V/f w/PG	Open Loop Vector	Flux Vector
-----	----------	------------------	-------------

E2 Motor Set-up

E2-01 Motor Rated Current **Motor Rated FLA**

Q	Q	Q	Q
---	---	---	---

Sets the motor rated current in units of 0.01A for inverter models 27P5, 47P5 and smaller; 0.1A for models G5U2011, G5U4011 and larger. The default setting varies depending on the inverter model setting (O2-04).

E2-02 Motor Rated Slip Frequency **Motor Rated Slip**

A	A	Q	Q
---	---	---	---

Setting range: 0.00 to 20.00Hz

Sets the motor rated slip frequency in units of 0.01Hz. The default setting varies depending on the inverter model setting (O2-04). Use the following equation to calculate the motor rated slip frequency:

$$f_s = f - \frac{(N \cdot P)}{120}$$

where:
 f_s : slip frequency (Hz)
 f : rated frequency (Hz)
 N : rated motor speed (rpm)
 P : number of motor poles

E2-03 Motor No-Load Current **No-Load Current**

A	A	Q	Q
---	---	---	---

Sets the motor no-load current in units of 0.01A for inverter models 27P5, 47P5 and smaller; 0.1A for models G5U2011, G5U4011 and larger. The default setting varies depending on the inverter model setting (O2-04).

E2-04 Number of Motor Poles **Number of Poles**

-	Q	-	Q
---	---	---	---

Setting Range: 2 to 48 poles
 Factory Default: 4 poles

Sets the number of motor poles.

E2-05 Motor Terminal Resistance **Term Resistance**

A	A	A	A
---	---	---	---

Sets the motor phase-to-phase resistance value in units of 0.01W.

$$\text{Motor Terminal Resistance} = \frac{\text{Phase-to-Phase Resistance at Insulation Class Temperature}}{\text{Insulation Class Temperature}} \times \frac{273 + (25^\circ\text{C} + \text{insulation class temperature}) / 2}{273 + \text{insulation class temperature}}$$

The default setting varies depending on the inverter model setting (O2-04).

Section E: Motor Parameters
E2 Motor 1 Set-up

V/f	V/f w/PG	Open Loop Vector	Flux Vector
-----	----------	------------------	-------------

E2-06	<i>Leakage Inductance</i>	<i>Leak Inductance</i>	—	—	A	A
-------	---------------------------	------------------------	---	---	---	---

Sets the motor leakage inductance in units of 0.1%. The default setting varies depending on the inverter model setting (O2-04).

E2-07	<i>Core-Saturation Compensation Coefficient 1</i>	<i>Saturation Comp1</i>	—	—	A	A
-------	---	-------------------------	---	---	---	---

Setting Range: 0.00 to 1.00
 Factory Default: 0.5

Sets the motor iron core saturation coefficient at 50% of the magnetic flux. This parameter is set automatically during auto-tuning, so it does not need to be changed.

E2-08	<i>Core-Saturation Compensation Coefficient 2</i>	<i>Saturation Comp2</i>	—	—	A	A
-------	---	-------------------------	---	---	---	---

Setting Range: 0.00 to 1.00
 Factory Default: 0.75

Sets the motor iron core saturation coefficient at 75% of the magnetic flux. This parameter is set automatically during auto-tuning, so it does not need to be changed.

E2-09	<i>Motor Mechanical Loss</i>	<i>Mechanical Loss</i>	—	—	—	A
-------	------------------------------	------------------------	---	---	---	---

Setting Range: 0.0 to 10.0%
 Factory Default: 0.0%

Sets the motor mechanical loss as a percentage of motor rated output power, in units of 0.1%.

E2-10	<i>Motor Iron Loss Torque Compensation <1110></i>	<i>Tcomp Iron Loss</i>	A	A	—	—
-------	---	------------------------	---	---	---	---

Setting Range: 0 to 65535
 Factory Default: 14 (Factory default depends on inverter capacity.)

This parameter sets the motor iron loss of the torque compensation.

V/f	V/f w/PG	Open Loop Vector	Flux Vector
-----	----------	------------------	-------------

E3 Motor 2 Set-up

E3-01 Motor 2 Control Method Selection

Control Method

A	A	A	A
---	---	---	---

The G5 inverter has the capability to control 2 motors independently. A second motor may be selected using a multi-function contact input.

Select the control method best suited for your application for Motor 2.

Setting	Description
0	V/f Control - For general-purpose and multiple motor applications.
1	V/f with PG Feedback - For general-purpose applications requiring closed loop speed control.
2	Open Loop Vector (<i>factory default</i>) - For applications requiring precise speed control, quick response and higher torque at low speeds (150% torque below 1Hz).
3	Flux Vector - For applications requiring very precise speed and torque control at a wide speed range including 0 speed. Uses encoder feedback.

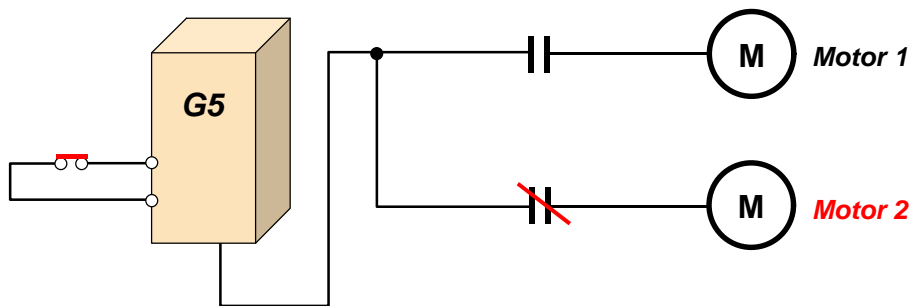

The following is a list of parameters that become effective when motor 2 is selected.

Function E3 Control Method 2		Function E4 V/F Pattern 2		Function E5 Motor Setup 2	
E3-01	Control Method 2	E4-01	Max Frequency	E5-01	Motor Rated FLA
		E4-02	Max Voltage	E5-02	Motor Rated Slip
		E4-03	Base Frequency	E5-03	No-Load Current
		E4-04	Mid Frequency	E5-05	Term Resistance
		E4-05	Mid Voltage	E5-06	Leak Inductance
		E4-06	Min Frequency		
		E4-07	Min Voltage		

The inverter must be stopped to switch motors.

E4 Motor 2 V/F Pattern / E5 Motor 2 Set-up

V/f	V/f w/PG	Open Loop Vector	Flux Vector
-----	----------	------------------	-------------

The motor 2 parameters are identical to the motor 1 parameters. Refer to E1-03 through E1-10.

E4-01	Motor 2 Maximum Frequency	Max Frequency	A	A	A	A
E4-02	Motor 2 Maximum Voltage	Max Voltage	A	A	A	A
E4-03	Motor 2 Base Frequency	Base Frequency	A	A	A	A
E4-04	Motor 2 Middle Output Frequency A	Mid Frequency A	A	A	A	—
E4-05	Motor 2 Middle Output Voltage A	Mid Voltage A	A	A	A	—
E4-06	Motor 2 Minimum Output Frequency	Min Frequency	A	A	A	A
E4-07	Motor 2 Minimum Output Voltage	Min Voltage	A	A	AA	—

E5 Motor 2 Set-up

E5-01	Motor 2 Rated Current	Motor Rated FLA	A	A	A	A
-------	-----------------------	-----------------	---	---	---	---

Sets the motor rated current in units of 0.01A for inverter models 27P5, 47P5 and smaller; 0.1A for models G5U2011, G5U4011 and larger. The default setting varies depending on the inverter model setting (O2-04).

E5-02	Motor 2 Rated Slip Frequency	Motor Rated Slip	A	A	A	A
-------	------------------------------	------------------	---	---	---	---

Setting range: 0.00 to 20.00Hz

Sets the motor rated slip frequency in units of 0.01Hz. The default setting varies depending on the inverter model setting (O2-04). Use the following equation to calculate the motor rated slip frequency:

$$f_s = f - \frac{(N \cdot P)}{120}$$

- where:
- f_s : slip frequency (Hz)
 - f : rated frequency (Hz)
 - N : rated motor speed (rpm)
 - P : number of motor poles

E5-03	Motor 2 No-Load Current	No-Load Current	A	A	A	A
-------	-------------------------	-----------------	---	---	---	---

Sets the motor no-load current in units of 0.01A for inverter models 27P5, 47P5 and smaller; 0.1A for models G5U2011, G5U4011 and larger. The default setting varies depending on the inverter model setting (O2-04).

E5-04	Motor 2 Number of Motor Poles	Number of Poles	—	A	—	A
-------	-------------------------------	-----------------	---	---	---	---

Setting Range: 2 to 48 poles
 Factory Default: 4 poles

Sets the number of motor poles for motor 2.

V/f	V/f w/PG	Open Loop Vector	Flux Vector
-----	----------	------------------	-------------

E5-05 Motor 2 Terminal Resistance

Term Resistance

A	A	A	A
---	---	---	---

Sets the motor phase-to-phase resistance value in units of 0.01W.

$$\text{Motor Terminal Resistance} = \frac{\text{Phase-to-Phase Resistance at Insulation Class Temperature}}{\text{Insulation Class Temperature}} \times \frac{273 + (25^\circ\text{C} + \text{insulation class temperature}) / 2}{273 + \text{insulation class temperature}}$$

The default setting varies depending on the inverter model setting (O2-04).

E5-06 Motor 2 Leakage Inductance

Leak Inductance

A	—	A	A
---	---	---	---

Sets the motor leakage inductance in units of 0.1%. The default setting varies depending on the inverter model setting (O2-04).

F Option Parameters

F1 PG Option Set-up

These parameters can be accessed during operation using a pulse generator (PG) for speed feedback.

When access level is BASIC (A1-03), the parameter is not displayed unless the option card is connected.

F1-01 PG Pulses per Revolution

PG Pulses/Rev

—	Q	—	Q
---	---	---	---

Setting Range: 0 to 60000

Factory Default: 1024

Sets the number of PG pulses per motor revolution (pulses/rev).

F1-02 PG Disconnection Detection Stopping Method

PG Fdbk Loss Sel

—	B	—	B
---	---	---	---

Selects the stopping method when a disconnected PG is detected.

Setting	Description
0	Ramp to stop - according to C1-02
1	Coast to stop (factory default)
2	Fast-stop according to C1-09
3	Alarm flashes, operation continues (this setting is disabled during flux vector control)

Section F: Option Parameters
F1 PG Option Set-up

V _f	V _f w/PG	Open Loop Vector	Flux Vector
----------------	---------------------	------------------	-------------

F1-03 Overspeed Detection Stopping Method **PG Overspeed Sel**

—	B	—	B
---	---	---	---

Selects the stopping method when an overspeed condition is detected.

Setting	Description
0	Ramp to stop - according to C1-02
1	Coast to stop (<i>factory default</i>)
2	Fast-stop according to C1-09
3	Alarm flashes, operation continues (this setting is disabled during flux vector control)

F1-04 PG Deviation Detection Stopping Method **PG Deviation Sel**

—	B	—	B
---	---	---	---

Selects the stopping method when excessive speed deviation is detected.

Setting	Description
0	Ramp to stop - according to C1-02
1	Coast to stop
2	Fast-stop according to C1-09
3	Alarm flashes, operation continues (<i>factory default</i>)

F1-05 PG Rotation Selection **PG Rotation Sel**

—	B	—	B
---	---	---	---

Sets the relationship between the motor rotation direction and PG polarity.

Setting	Description
0	Motor FWD direction is counterclockwise (<i>factory default</i>).
1	Motor FWD direction is clockwise.

The motor rotation direction applies when viewing the motor shaft from the load side.

F1-06 PG Division Rate (pulse output) **PG Output Ratio**

—	B	—	B
---	---	---	---

Setting Range: 1 to 132

Factory Default: 1

Sets the division ratio for monitoring the PG pulse signals.

V/f	V/f w/PG	Open Loop Vector	Flux Vector
-----	----------	------------------	-------------

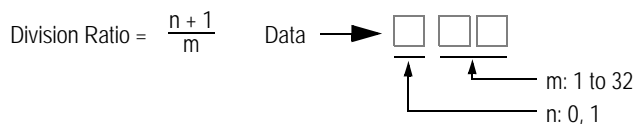

Setting Example:
 When F1-06 is set to "132", then the division ratio = $\frac{1+1}{32} = \frac{2}{16}$

This parameter is effective only when the printed circuit board PG-B2 is used

F1-07 Integral Value During Accel/Decel **PG Ramp PI/I Sel**

-	B	-	-
---	---	---	---

Selects whether speed control (ASR) integral operation is activated during acceleration/deceleration.

Setting	Description
0	Integral operation disabled (<i>factory default</i>)
1	Integral operation enabled

F1-08 Overspeed Detection Level **PG Overspd Level**

-	A	-	A
---	---	---	---

Setting Range: 0 to 120%
 Factory Default: 115%

Sets the motor overspeed detection level as a percentage of maximum output frequency (E1-04).

F1-09 Overspeed Detection Time **PG Overspd Time**

-	A	-	A
---	---	---	---

Setting Range: 0.0 to 2.0s
 Factory Default: 0.0s

Sets the elapsed time from when an overspeed condition is detected to when a fault occurs.

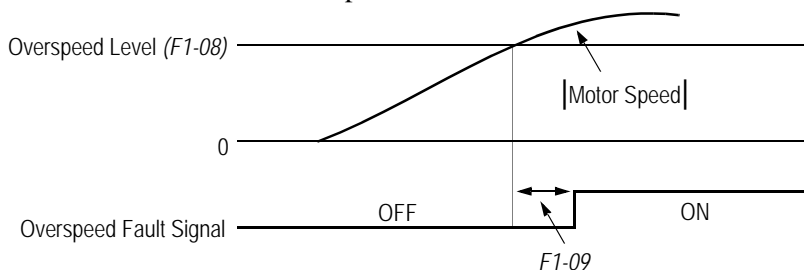

Figure 29 Overspeed Detection Timing Diagram

A fault signal is output to stop operation after the absolute value of the motor speed exceeds the set value of F1-08 and after the time set to F1-09 elapses. The stopping method is set by F1-03.
 When parameter A1-02=1 [V/f w/PG] the factory setting will be 1.0. When parameter A1-02=3 [Flux Vector] the factory setting will be 0.0.

Section F: Option Parameters
F1 PG Option Set-up

V/f	V/f w/PG	Open Loop Vector	Flux Vector
-----	----------	------------------	-------------

F1-10 PG Deviation Detection Level

PG Deviate Level

—	A	—	A
---	---	---	---

Setting Range: 0 to 50%
 Factory Default: 115%

Sets the excessive speed deviation detection level as a percentage of maximum output frequency (*E1-04*).

F1-11 PG Deviation Detection Time

PG Deviate Time

—	A	—	A
---	---	---	---

Setting Range: 0.0 to 2.0s
 Factory Default: 0.0s

Sets the elapsed time from when excessive speed deviation is detected to when a fault occurs.

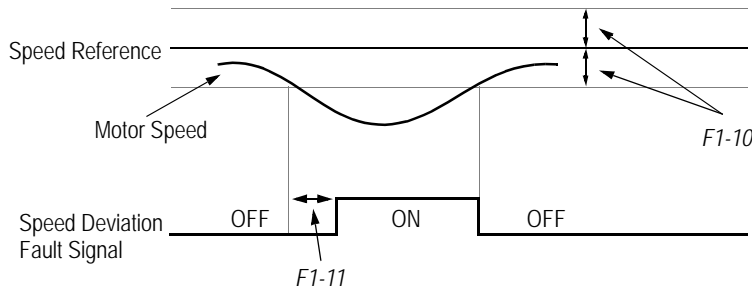

Figure 30 Overspeed Detection Timing Diagram

A fault signal is output to stop operation after the deviation between speed reference and the motor speed exceeds the set value of *F1-10* and after the time set to *F1-11* elapses. The stopping method is set by *F1-04*. Also, detection is not activated while accelerating/decelerating or during torque control.

F1-12 Number of Teeth Gear 1

PG # Gear Teeth1

—	A	—	—
—	A	—	—

F1-13 Number of Teeth Gear 2

PG # Gear Teeth2

Setting Range: 0 to 1000
 Factory Default: 0

Sets the number of teeth for each gear when gears are installed between the motor and the PG. When the number of gear teeth is set, the motor revolutions per minute (rpm) are calculated as shown below.

$$\text{No. of Motor RPM's} = \frac{\text{No. of PG Output Pulses} \times 60}{\text{PG Pulses/Revolution (F1-01)}} \times \frac{\text{No. of Teeth Gear 2 (F1-13)}}{\text{No. of Teeth Gear 1 (F1-12)}}$$

This function is disabled when either *F1-12* or *F1-13* = “0”.

V/f	V/f w/PG	Open Loop Vector	Flux Vector
-----	----------	------------------	-------------

F1-14 PGO Detection Time

PGO Detect Time

—	A	—	A
---	---	---	---

Setting Range: 0.0 to 10 seconds
 Factory Default: 2 seconds

Parameter F1-14 sets the time from when the pulse generator (PG) signal is missing to when the fault signal is displayed.

The stopping method when a “PGO” fault is detected is selected by parameter F1-02.

If a speed reference is commanded, but the motor is physically locked, a “PGO” fault will occur even though the PG is not disconnected from the inverter.

F2 AI-14B Set-up

F2-01 Bipolar or Unipolar Input Selection

AI-14 Input Sel

A	A	A	A
---	---	---	---

Sets CH1 to CH3 input functions when AI-14B option is connected.

Setting	Function	CH1 (TC1 to TC4)	CH2 (TC2 to TC4)	CH3 (TC3 to TC4)
0	3-channel individual input (<i>factory default</i>)	Substitute for terminals 13 and 17	Substitute for terminals 14 and 17	Substitute for terminals 16 and 17
1	3-channel additional input	Sum of CH1 to CH3 input values is used as the frequency reference value.		

When the 3CH individual input is used, parameter *BI-01* is automatically set to “1” (frequency reference from control circuit terminal). The option/inverter reference selection, which is selected by a multi-function contact input (*HI-__* = “2”), is disabled when using the AI-14B option.

V/f	V/f w/PG	Open Loop Vector	Flux Vector
-----	----------	------------------	-------------

F3 DI-08/DI-16H Set-up

F3-01 Digital Input Option

DI Input

A	A	A	A
---	---	---	---

Selects the setting mode of the frequency reference input from the DI-08 and DI-16H options.

Setting	Frequency Reference Setting Mode
0	BCD 1% unit (<i>factory default</i>)
1	BCD 0.1% unit
2	BCD 0.01% unit
3	BCD 1Hz unit
4	BCD 0.1Hz unit
5	BCD 0.01Hz unit
6	Binary DI-08: 255/100% DI-16H, 12-bit selection: 4096/100% DI-16H, 16-bit selection: 30000/100%
7	Binary, set value is displayed in decimal notation.

F4 AO-08/AO-12 Set-up

F4-01 Analog Output Channel 1 Selection

AO CH1 Select

A	A	A	A
---	---	---	---

Selects the analog output monitors for channel 1 of the AO-08 and AO-12 options.

Analog Output Channel 1 Selection

F4-01 Setting	Function	Description
1	Frequency reference	Monitors the frequency reference value. 10V= Max frequency (0-+/-10V possible)
2	Output frequency (<i>factory default</i>)	Monitors the output frequency. 10V= Max frequency (0-+/-10V possible)
3	Inverter output current	Monitors the output current. 10V=Rated current (0 to +10V output)
5	Motor speed	Monitors the motor speed. 10V= Max frequency (0 to +/- 10 V possible)
6	Output voltage	Monitors the inverters internal output voltage reference value. 10V=200,400 or 575 VAC
7	DC bus voltage	Monitors the DC voltage of the inverters internal main circuit. 10V=400 or 800 VDC (0 to +10V output)
8	Output power	Monitors the output power, this is an internally detected value. 10V=Max motor capacity. (0 to +/-10 V possible)
9	Torque reference (internal)	Monitors the internal torque reference value when vector control is used. 10 V=Rated torque. (0 to +/-10V possible)
10-14	Not Used	--
15	Terminal 13 input voltage level	Monitors the input voltage of the frequency reference (voltage). An input of 10 V corresponds to 100%. 10 V=100% (10 V) 0 to +/-10 V possible.
16	Terminal 14 input voltage or current level	Monitors the input current of the frequency reference. (current) An input of 20 mA corresponds to 100%. 20 mA=100% (20 mA) 0 to + 10 V output.
17	Terminal 16 input voltage level	Monitors the input voltage of the multi-function analog input. An input of 10 V corresponds to 100%. 10 V= 100% (10 V). (0 to +/-10 V possible)

V/f	V/f w/PG	Open Loop Vector	Flux Vector
-----	----------	------------------	-------------

Analog Output Channel 1 Selection (Continued)

F4-01 Setting	Function	Description
18	Motor secondary current (Iq)	Monitors the calculated value of the motors secondary current. (Iq) The motors rated secondary current corresponds to 100%. 10 V=Rated secondary current. (0 to + 10 V output)
19	Motor excitation current (Id)	Monitors the calculated value of the motors excitation current. (Id) The motors rated excitation current corresponds to 100%. 10 V=Rated excitation current. (0 to + 10 V output).
20	SFS output frequency	Monitors the output frequency after a soft start. This is the frequency without the correction from compensation functions such as slip compensation. 10 V=Max. frequency (0 to +/- 10 V possible)
21	ASR input	Monitors the input to the speed control loop. The max. frequency corresponds to 100%. 10 V=Max. frequency (0 to +/- 10 V possible)
22	ASR output	Monitors the output from the speed control loop. Analog monitor becomes 10 V/ max. output frequency with V/F control. In vector control the analog monitor becomes 10V= motor rated excitation current. (0 to +/-10V possible.)
23	Speed deviation	Monitors the speed deviation within the speed control loop. The max. frequency corresponds to 100%. 10 V=Max. frequency (0 to +/-10 V possible.)
24	PID feedback	Monitors the feedback value when the PID control is utilized. The input for the max. frequency corresponds to 100%. 10 V= Max frequency. (0 to +/-10 V possible.)
25	Not Used	--
26	Voltage reference (Vq output)	Monitors the inverters internal voltage reference value for the motors secondary current control. 10 V= 200,400 or 575 VAC (0 to +/- 10 V possible.)
27	Voltage reference (Vd output)	Monitors the inverters internal voltage reference value for the motors excitation current control. 10 V= 200,400 or 575 VAC (0 to +/- 10 V possible.)
28-30	Not Used	--
31	Not Used	--
32	ACR(q) Output	Monitors current control output value for the motors secondary current. 10 V= 100%.
33	ACR(d) Output	Monitors current control output value for the motors excitation current. 10 V= 100%.
34-35	Not Used	--
36	PID Input Monitor	Monitors the input to the PID circuit. This is the PID reference + the PID reference bias - the PID feedback. 10 V= Max frequency.
37	PID Output Monitor	Monitors the output of the PID circuit. 10 V= Max frequency.
38	PID Setpoint or Reference	Monitors the PID setpoint. This is the PID setpoint + the PID setpoint bias. 10 V= Max frequency.

F4-02 Analog Output Channel 1 Gain

AO CH1 Gain

A	A	A	A
---	---	---	---

Setting Range: 0.00 to 2.50
 Factory Default: 1.00

Sets the channel 1 output gain for the analog output monitors. To obtain the output level, multiply the monitor output level by the gain value set in F4-02.

Section F: Option Parameters
F4 AO-08/AO-12 Option Set-up

Vf	Vf w/PG	Open Loop Vector	Flux Vector
----	---------	------------------	-------------

F4-03 Analog Output Channel 2 Selection *AO CH2 Select*

A	A	A	A
---	---	---	---

Setting Range: Same as *F4-01*
 Factory Default: Inverter output current (setting = “3”)

Selects the analog output monitors for channel 2 of the AO-08 and AO-12 options.

F4-04 Analog Output Channel 2 Gain *AO CH2 Gain*

A	A	A	A
---	---	---	---

Setting Range: 0.00 to 2.50
 Factory Default: 0.50

Sets the channel 2 output gain for the analog output monitors. To obtain the output level, multiply the monitor output level by the gain value set in *F4-04*.

F4-05 Analog Output Channel 1 Bias *AO CH1 Bias*

A	A	A	A
---	---	---	---

Setting Range: -10.0 to + 10.0
 Factory Default: 0.0

Sets the channel 1 output bias for the analog output monitors. This is for the AO-08 and AO-12 option cards.

F4-06 Analog Output Channel 2 Bias *AO CH2 Bias*

A	A	A	A
---	---	---	---

Setting Range: -10.0 to + 10.0
 Factory Default: 0.0

Sets the channel 2 output bias for the analog output monitors. This is for the AO-08 and AO-12 option cards.

V/f	V/f w/PG	Open Loop Vector	Flux Vector
-----	----------	------------------	-------------

F5 DO-02 Set-up

The DO-02C option card has 2 form C type dry contacts. Each of the dry contacts can be individually set by F5-01 and F5-02.

The DO-02C option card connects to the control board at 3CN.

The table is a list of items that can be selected.

F5-01 DO-02C Digital Output Channel 1 Selection DO-02 CH1 Select

A	A	A	A
---	---	---	---

Selects the multi-function output selections for channel 1 of the DO-02C option.

For detailed information on these settings, refer to section **H2, Digital Outputs**, on page 88.

Setting	Description	Setting	Description
0	During run 1 (<i>factory default</i>)	13	Fref/Fout agree 2
1	Zero speed	14	Fref/set agree 2
2	Fref/Fout agree 1	15	Frequency detection 3
3	Fref/set agree 1	16	Frequency detection 4
4	Frequency detection 1	17	Torque detection 1 (N.C.)
5	Frequency detection 2	18	Torque detection 2 (N.O.)
6	Inverter ready	19	Torque detection 2 (N.C.)
7	DC bus undervoltage	1A	Reverse direction
8	Baseblock 1	1B	Baseblock 2
9	Option frequency reference	1C	Motor 2 selected
A	Remote operation	1D	Regenerating
B	Torque detection 1 (N.O.)	1E	Restart enabled
C	Loss of reference	1F	Overload (OL1)
D	DB overheat	20	OH pre-alarm
E	Fault	30	Current/torque limit
F	Not used	31	Speed limit
10	Minor fault	33	Zero servo end
11	Reset command active	37	During run 2
12	Timer output	-	--

F5-02 DO-02C Digital Output Channel 2 Selection DO-02 CH2 Select

A	A	A	A
---	---	---	---

Setting Range: Same as *F5-01*

Factory Default: Zero speed (setting = "1")

Selects the multi-function output selections for channel 2 of the DO-02C option.

Vf	Vf w/PG	Open Loop Vector	Flux Vector
----	---------	------------------	-------------

F6 DO-08 Set-up

F6-01 DO-08 Digital Output Selection

DO-08 Selection

A	A	A	A
---	---	---	---

Selects the multi-function output selections for the DO-08 option.

Setting	Terminal No.	Description
0 8-channel individual (factory default)	TD5/TD11	Overcurrent (SC, OC, GF)
	TD6/TD11	Overvoltage (OV)
	TD7/TD11	Inverter overload (OL2)
	TD8/TD11	Fuse blown (FU)
	TD9/TD11	Not used
	TD10/TD11	Inverter overheat (OH)
	TD1/TD2	During zero-speed detection
	TD3/TD4	During speed agree
1 binary output	TD5/TD11	Binary output *
	TD6/TD11	
	TD7/TD11	
	TD8/TD11	
	TD9/TD11	During zero-speed detection
	TD10/TD11	During speed agree
	TD1/TD2	During run
	TD3/TD4	Minor fault

* When F6-01 is set to binary output (setting = "1"), use the table below to read the DO-08 output.

TD8/TD11 (bit 3)	TD7/TD11 (bit 2)	TD6/TD11 (bit 1)	TD5/TD11 (bit 0)	Description
0	0	0	0	No fault
0	0	0	1	Overcurrent (SC, OC, GF)
0	0	1	0	Overvoltage (OV)
0	0	1	1	Inverter overload (OL2)
0	1	0	0	Inverter overheat (OH)
0	1	0	1	Overspeed (OS)
0	1	1	0	Fuse blown (FU)
0	1	1	1	Not used
1	0	0	0	External fault (EF3 ~ EF8)
1	0	0	1	Controller fault
1	0	1	0	Motor overload (OL1)
1	0	1	1	Not used
1	1	0	0	Power loss (UV1, UV2, UV3)
1	1	0	1	Excessive speed deviation (DEV)
1	1	1	0	PG disconnection (PGO)
1	1	1	1	Not used

Note: When the terminal is open, the bit setting is "0"; when the terminal is closed, the bit setting is "1".

V/f	V/f w/PG	Open Loop Vector	Flux Vector
-----	----------	---------------------	----------------

F7 PO-36F Set-up

The PO-36F option card outputs pulse signals that correspond to the inverter output frequency. These signals are used in master/slave configurations where speed matching is needed.

F7-01 PO-36F Pulse Monitor Output Selection PO-36F Selection

A	A	A	A
---	---	---	---

Sets the number of pulse signals to be output from the PO-36F option.

Setting	Number of Output Pulses
0	Inverter output frequency × 1
1	Inverter output frequency × 6 (<i>factory default</i>)
2	Inverter output frequency × 10
3	Inverter output frequency × 12
4	Inverter output frequency × 36

F8 Function F8 SI-F/G Set-up

The setting of parameter F8-01 selects the stopping method when an E-15 fault is detected.

F8-01 (*E-15*) Detection Stopping Method *E-15 Det Sel*

A	A	A	A
---	---	---	---

An E-15 fault may occur when using the SI-F or SI-G communication options. The fault will occur after initial communication has been established then the connection is lost. The following fault code will be displayed:

Setting	Description
0	Ramp to stop according to C1-02 set value
1	<i>Coast to stop.</i>
2	Ramp to stop according to C1-09 set value.
3	Alarm flashes, operation continues.

V/f	V/f w/PG	Open Loop Vector	Flux Vector
-----	----------	------------------	-------------

F9 CP-916 Setup

The CP-916 option card provides PLC and motion type functions. This allows the G5 inverter to be a stand alone control system.

The CP-916 option card connects to the control board at 3CN.

When the CP-916 option is installed, the 4CN speed feedback option port is the only option port that is supported.

Specifications

- RS 232C communication port - Used for programming the CP-916G and for communication to other devices such as PLC's or printers.
- High speed (4 Mb/s) peer to peer communication port.
- Available protocol;
 MEMOBUS (MODBUS) 19.2 kbps maximum.
 Application Download Tool 19.2 kbps maximum.
 CP 717 Programming Tool 9.6 kbps.

F9-01 *Option External Fault Selection*

EFO Selection

A	A	A	A
---	---	---	---

Parameter F9-01 selects the initial state for an external fault condition when the inverter is configured for serial communication using the CP-916.

Setting	Description
0	When closed, the inverter will trip. (factory default)
1	When open, the inverter will trip.

The “EFO” fault code will be displayed.

F9-02 *Option External Fault Detection*

EFO Detection

A	A	A	A
---	---	---	---

Parameter F9-02 selects the condition of detection for an external fault when using the CP-916 option.

Setting	Description
0	The fault will always be detected, even when the drive is stopped. (factory default)
1	The fault will be detected only when the drive is running.

V/f	V/f w/PG	Open Loop Vector	Flux Vector
-----	----------	------------------	-------------

F9-03 *Option External Fault Action*

EFO Fault Action

A	A	A	A
---	---	---	---

The setting of parameter F9-03 selects the stopping method when an EFO fault is detected.

Setting	Description
0	Ramp to stop according to C1-02 set value.
1	<i>Coast to stop. (factory setting)</i>
2	Ramp to stop according to C1-09 set value.
3	Alarm flashes, operation continues.

F9-04 *Trace Sample Time*

Trace Sample Tim

A	A	A	A
---	---	---	---

Setting Range: 0-60000

Factory Default: 0

Parameter F9-04 sets the trace sample time when using the CP-916B option card.

F9-05 *Torque Reference/Torque Limit Select (CP-916)* *Torq Ref/Lmt Sel*

-	-	-	A
---	---	---	---

Parameter F9-05 allows the CP-916 option card to set the torque limits when the inverter is in the speed control mode and the torque reference when operating in the torque control mode

Setting	Description
0	Disabled - Torque reference/torque limits set by G5 program parameters or by analog input.
1	<i>Enabled - Torque reference/torque limits set by G5 program parameters, analog input, or by the CP-916. (factory default)</i>

Operation Truth Table for Parameter F9-05

Set Value	Speed Control (Torque Limit)	Torque Control (Torque Reference)
F9-05 = 0	Set by parameter or analog input.	Set by analog input terminal 14 or 16.
F9-05 = 1	Set by CP-916 option card, parameter, or analog input.	Set by CP-916 option card.

Note: The inverter will use the lowest value from the CP-916, L7-01 to L7-04, or the multi-function analog input terminals 14 or 16.

V/f	V/f w/PG	Open Loop Vector	Flux Vector
-----	----------	------------------	-------------

F9-06 Bus Fault Select

Bus Fault Sel

A	A	A	A
---	---	---	---

The setting of parameter F9-06 selects the stopping method when an BUS fault is detected. A BUS fault may occur when using the SI-B or the CP-916 communication options. The fault will occur after initial communication has been established then the connection is lost. The following fault code will be displayed: “BUS SI-B Com Err”.

Setting	Description
0	Ramp to Stop - Ramp to stop according to C1-02 set value.
1	<i>Coast to stop.</i>
2	Fast-Stop - Ramp to stop according to C1-09 set value.
3	Alarm Only - Alarm flashes, operation continues.

H Control Circuit Terminal Parameters
H1 Digital Inputs

The VS-616G5 has six multi-function contact inputs for the set-up of numerous functions, including multi-step speed operation, PID, speed search, speed/torque control selection, and many other. This section includes descriptions of these functions.

- H1-01 Multi-function Input Terminal 3 Selection*
- H1-02 Multi-function Input Terminal 4 Selection*
- H1-03 Multi-function Input Terminal 5 Selection*
- H1-04 Multi-function Input Terminal 6 Selection*
- H1-05 Multi-function Input Terminal 7 Selection*
- H1-06 Multi-function Input Terminal 8 Selection*

- Terminal 3 Sel*
- Terminal 4 Sel*
- Terminal 5 Sel*
- Terminal 6 Sel*
- Terminal 7 Sel*
- Terminal 8 Sel*

B	B	B	B
B	B	B	B
B	B	B	B
B	B	B	B
B	B	B	B
B	B	B	B

The following table lists the function selections for the multi-function contact inputs (terminals 4 to 8), and indicates the control modes during which each function can be enabled.

H1-01 to 6 Setting	Function	Control Method (A7-02)				Reference Page
		V/f	V/f w/ PG	Open Loop Vector	Flux Vector	
0	3-Wire Control	√	√	√	√	
1	Local/Remote Selection	√	√	√	√	
2	Option/Inverter Selection	√	√	√	√	
3	Multi-Step Ref. 1 (<i>factory default, H1-03</i>)	√	√	√	√	
4	Multi-Step Ref. 2 (<i>factory default, H1-04</i>)	√	√	√	√	
5	Multi-Step Reference 3	√	√	√	√	
6	Jog Frequency Ref. (<i>factory default, H1-05</i>)	√	√	√	√	
7	Multi-Accel/Decel 1	√	√	√	√	
8	Ext. Baseblock N.O. (<i>factory default, H1-06</i>)	√	√	√	√	
9	External Baseblock N.C.	√	√	√	√	
A	Accel/Decel Ramp Hold	√	√	√	√	
B	OH2 Alarm Signal	√	√	√	√	
C	Terminal 16 Enable	√	√	√	√	
D	V/f Mode Selection	–	√	–	–	
E	ASR Integral Reset	–	√	–	√	
10	MOP Increase	√	√	√	√	
11	MOP Decrease	√	√	√	√	

H1-01 to 6 Setting	Function	Control Method (A1-02)				Reference Page
		V/f	V/f w/ PG	Open Loop Vector	Flux Vector	
12	Forward Jog	√	√	√	√	
13	Reverse Jog	√	√	√	√	
14	Fault Reset (<i>factory default, H1-02</i>)	√	√	√	√	
15	Fast-Stop	√	√	√	√	
16	Motor 2 Select	√	√	√	√	
17	Fast-Stop (Closed, motor decels by C1-09) <1110>	√	√	√	√	
18	Timer Function	√	√	√	√	
19	PID Disable	√	√	√	√	
1A	Multi-Accel/Decel 2	√	√	√	√	
1B	Program Lockout	√	√	√	√	
1C	Trim Control Increase	√	√	√	√	
1D	Trim Control Decrease	√	√	√	√	
1E	Reference Sample Hold	√	√	√	√	
1F	Terminal 13/14 Switch	√	√	√	√	
20-2F	External Fault (<i>factory default, H1-01</i>)	√	√	√	√	
30	Closed: PID Integral is Reset	√	√	√	√	
31	Closed: PID Integral Value is Held <1110>	√	√	√	√	
60	DC Injection Activate	√	√	√	√	
61	Speed Search 1	√	—	√	—	
62	Speed Search 2	√	—	√	—	
63	Energy Saving Command	√	√	—	—	
64	Speed Search 3	√	√	√	√	
65	KEB Ridethrough N.C.	√	√	√	√	
66	KEB Ridethrough N.O	√	√	√	√	
71	Speed/Torque Control Change	—	—	—	√	
72	Zero Servo Command	—	—	—	√	
77	ASR Gain Switch	—	—	—	√	

• 3-Wire Control (setting: “0”)

When *H1-__* is set to “0”, 3-wire control is enabled. The terminal set to “0” becomes the FWD/REV run command.

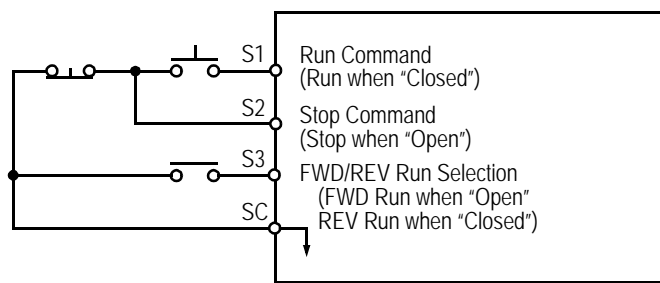

Figure 31 Terminal Function at 3-Wire Sequence Selection (*H1-__* = “0”)

V/f	V/f w/PG	Open Loop Vector	Flux Vector
-----	----------	------------------	-------------

· Local/Remote Selection (setting: “1”)

Selects the operation mode, only when the inverter is stopped.

Local: Operation according to frequency reference and run command from digital operator.

Remote: Operation according to frequency reference and run command set by *B1-01* and *B1-02*, respectively.

Note: When local/remote selection is set by a multi-function contact input terminal, local/remote selection from the digital operator key is disabled.

· Option/Inverter Selection (setting: “2”)

Selects whether operation is performed using a reference command from an option card or from the inverter. Selection is effective only when the inverter is stopped.

Open: Runs by frequency reference and run command from inverter control circuit terminal or digital operator.

Closed: Runs by frequency reference and run command from an option card.

Multi-Step Ref 1 through 3 and Jog Freq Ref (Set value = 3, 4, 5, and 6)

Terminal 8 (H1-06 = 6) Jog Freq Ref	Terminal 7 (H1-05 = 5) Multi-Step Ref 3	Terminal 6 (H1-04 = 4) Multi-Step Ref 2	Terminal 5 (H1-03 = 3) Multi-Step Ref 1	Preset Reference
O	O	O	O	Reference 1 (d1-01)
O	O	O	X	Reference 2 (d1-02)
O	O	X	O	Reference 3 (d1-03)
O	O	X	X	Reference 4 (d1-04)
O	X	O	O	Reference 5 (d1-05)
O	X	O	X	Reference 6 (d1-06)
O	X	X	O	Reference 7 (d1-07)
O	X	X	X	Reference 8 (d1-08)
X	—	—	—	Jog Reference (d1-09)

O - Open

X - Closed

-- Has no effect

d1-01 is effective when b1-01 is set to 0 (reference from the digital operator)

d1-02 is effective when the terminal 16 setting (H3-05) is set to anything other than zero.

V/f	V/f w/PG	Open Loop Vector	Flux Vector
-----	----------	------------------	-------------

It is possible to mix analog and digital references in the multi-speed input function. The parameters must be set as shown below

Parameter	Reference	Digital	Analog
(d1-01)	Reference 1	b1-01 = 0	b1-01 = 1 (terminal 13 or 14)
(d1-02)	Reference 2	H3-05 ≠ 0	H3-05 = 0 (terminal 16)
(d1-03)	Reference 3	d1-03	not available
(d1-04)	Reference 4	d1-04	
(d1-05)	Reference 5	d1-05	
(d1-06)	Reference 6	d1-06	
(d1-07)	Reference 7	d1-07	
(d1-08)	Reference 8	d1-08	
(d1-09)	Jog Reference	d1-09	

· Multi Accel/Dec1 (Set value = 7)

Open: Acceleration 1 / Deceleration 1 is set by parameters C1-01 and C1-02 respectively.
 Closed: Acceleration 2 / Deceleration 2 is set by parameters C1-03 and C1-04 respectively.

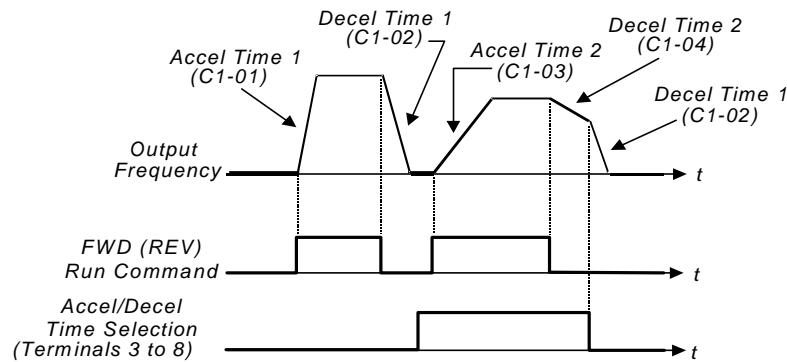

· External Baseblock N.O. (setting: “8”)

Baseblock operation is performed when the contact output is closed. External baseblock operation differs as described below, depending on the run command input status.

When an external baseblock signal is input while the inverter is running, BB blinks on the digital operator display, and the inverter output is shut OFF. When the external baseblock signal is removed, operation restarts at the previous frequency reference before baseblock. Output voltage is then increased up to its previous level before baseblock, in the voltage recovery time (L2-04).

When a stop signal is input and an external baseblock signal is input while the inverter is decelerating, BB blinks on the digital operator, the inverter output shuts OFF and the frequency reference is set to 0.

V/f	V/f w/PG	Open Loop Vector	Flux Vector
-----	----------	------------------	-------------

- External Baseblock N.C. (setting: “9”)

Baseblock operation is performed similar to setting “8”, except that operation is performed when the contact output is closed.
- Accel/Decel Hold Command (setting: “A”)

The accel/decel hold command is used to temporarily hold the output frequency at the current frequency reference, when the hold command is input. When a stop command is input, the accel/decel hold condition is released and operation stops.

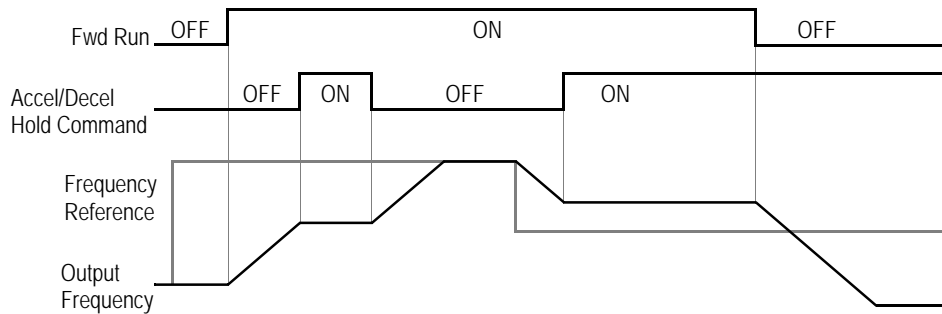

Figure 32 Accel/Decel Hold Command Timing Diagram

Notes:

1. When hold reference memory selection is enabled ($D4-01 = "1"$) and an accel/decel hold command is input, by inputting a run command again after a stop command is input, the held output frequency is stored unless the accel/decel stop command is released. Operation resumes at the stored frequency.
 2. When the power supply is turned OFF after the accel/decel hold command is input, the held output frequency is also stored.
 3. When $D4-01$ is set to “0”. the held output frequency is not stored,
- Inverter Overheat OH2 Alarm (setting: “B”)

When the inverter overheat alarm signal is input, OH2 blinks on the digital operator display. This contact can be connected to an external temperature switch for monitoring the inverter ambient temperature. A multi-function contact output ($H2- _$) can be set to “20” to close a contact at this condition.
 - Multi-function Analog Input Selection (setting: “C”)

This setting disables the terminal 16 multi-function analog input.

 - Open: Terminal 16 command is not accepted.
 - Closed: Terminal 16 command is accepted.
 - Feedback Mode During V/f Selection (setting: “D”)

Feedback input can be disabled while the inverter is running when this function is selected. However, the speed control integral value ($C5-05$) is held until stop.

 - Open: Feedback control enabled (closed loop)
 - Closed: Feedback control disabled (open loop)

This function is available only during V/f control with PG feedback.

V/f	V/f w/PG	Open Loop Vector	Flux Vector
-----	----------	------------------	-------------

- Speed Control Integral Value Reset (setting: “E”)

The speed control integral value can be reset while the inverter is running when this function is selected. Reset is effective only when integral control selection during accel/decel (*F1-07*) = “0”.

Open: PI-control (speed control integral values are added.)

Closed: P-control (speed control integral values are reset by the integral time constant.)
- Up/Down Command (settings: Up = “10”. Down = “11”)

With the FWD (REV) run command entered, a change in frequency is performed by inputting the Up or Down signals to any two contact inputs, so that operation can be performed at the desired speed.

UP command	Closed	Open	Open	Closed
DOWN command	Open	Closed	Open	Closed
Operation Status	Accel	Decel	Hold	Hold

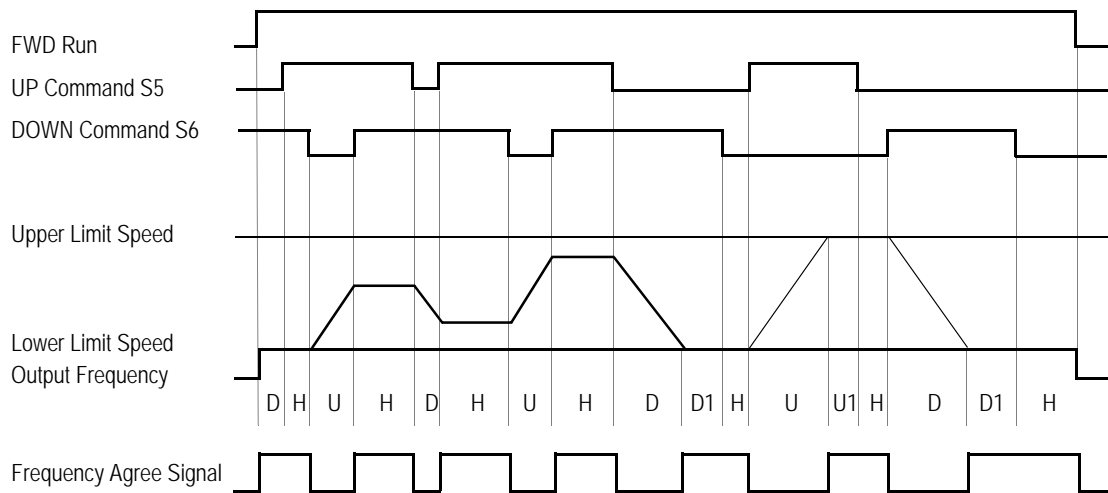

- U: Up (accelerating) status
- D: Down (decelerating) status
- H: Hold (constant speed) status
- U1: Up status, with clamping at upper limit speed
- D1: Down status, with clamping at lower limit speed

Figure 33 UP/DOWN Command Timing Diagram

Notes:

1. Be sure to set frequency reference selection (*B1-01*) = “1”. When *B1-01* = “0”, Up/Down operation is disabled.
2. Upper limit speed
 = Max. output frequency (*E1-04*) × Frequency reference upper limit (*D2-01*), if used
3. The lower limit value is either the master frequency reference from control circuit terminals 13 or 14, or the frequency reference lower limit (*D2-01*), whichever is larger.
4. When hold reference memory selection is enabled (*D4-01* = “1”) and a hold command is input, the held output frequency is stored even after the power supply is turned OFF. When *D4-01* = “0”, the held output frequency is *not* stored.
5. If the jog frequency reference is input during Up/Down operation, the jog frequency reference has priority.

Vf	Vf w/PG	Open Loop Vector	Flux Vector
----	---------	------------------	-------------

- Forward and Reverse JOG commands (settings: Fwd Jog = “12”, Rev Jog = “13”) Forward and reverse run jog frequency commands are enabled.

Setting	Description
12	Forward jog command is closed, run at jog frequency reference (D1-09).
13	Reverse jog command is closed, run at jog frequency reference (D1-09).

Notes:

1. When either the forward or reverse jog command is input during run, this command has priority.
 2. When both the forward and reverse jog commands are closed for more than 500ms, the inverter stops according to the stopping method selection (B1-03).
 3. The forward and reverse jog commands can be set independently.
- Fault Reset (setting: “14”) Closing this contact resets a fault after the condition is removed.
 - Fast-Stop (Set value = 15)
 Open: The inverter operates normally.
 Closed: The inverter decelerates to stop using deceleration time C1-09 (factory set to 10 sec.). The run command can remain closed during this period of time. The inverter will not run, from the external terminals or the digital operator as long as this input is closed.
 To restart the inverter, the run command must be cycled.
 - Motor 2 Select (Set value = 16)
 Open: Motor 1 is selected.
 Closed: Motor 2 is selected.
 When Motor 2 is selected, the following parameters are effective;

The inverter must be stopped to switch motors.

A multi-function digital output may be programmed when motor 2 is selected. Refer to page 88 for more information.

- Fast-Stop (setting: “17”) <1110>
 When this input is closed the motor decelerates to a stop using the rate defined by parameter C1-09.

- Timer Function (Set value = 18)
 The timer function works independently from the inverter.
 The timer input must be on longer than the time in b4-01 for the output to close.
 The timer input must be off longer than the time in b4-02 for the output to open.

b4-01 is the on-delay time setting (0.0 - 300.0 second)
 b4-02 is the off-delay time setting (0.0 - 300.0 second)

V/f	V/f w/PG	Open Loop Vector	Flux Vector
-----	----------	------------------	-------------

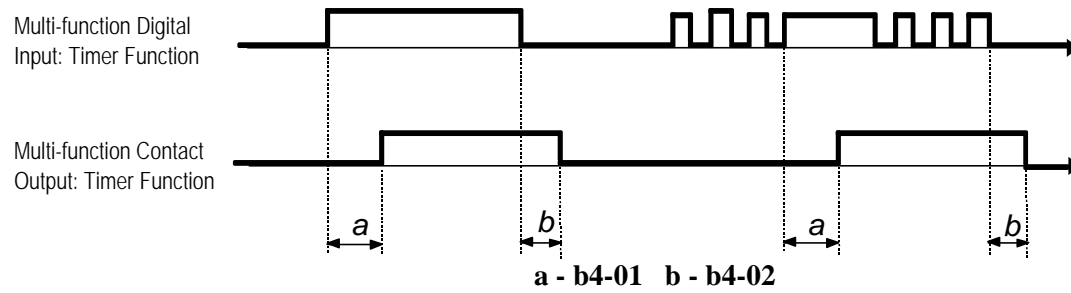

- PID Disable (Set value = 19)
 Open: PID control is enabled.
 Closed: PID control is disabled

- Program Lockout (setting: "1B")
 Opening this contact prohibits the changing of VS-616G5 parameters.
 - TrimCtl Increase (Set value = 1C)
 - TrimCtl Decrease (Set value 1D)
 Closed: Increases or decreases the output frequency based on the setting of d4-02 (trim control level). This function is not available when the reference is set from the digital operator.

- Analog Reference Sample/Hold Selection (setting: "1E")
 If the contact input closes for 100ms or longer, the analog frequency reference is sampled once, after which the analog frequency reference is held.

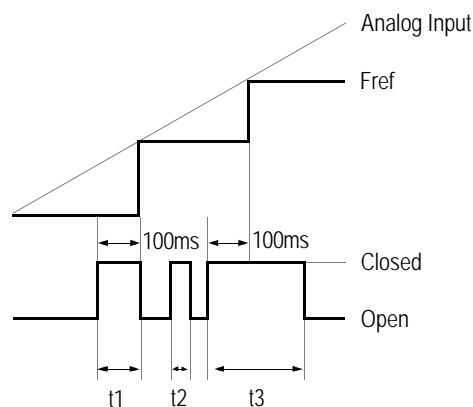

Figure 34 Sample/Hold Selection - Analog Reference

Note: t1, t3 - Reference is held at 100ms or longer.
 t2 - Reference is *not* held at less than 100ms.

Vf	Vf w/PG	Open Loop Vector	Flux Vector
----	---------	------------------	-------------

· Terminal 13/14 Selection (setting: “1F”)

- Open: Terminal 13 is used for the master frequency reference.
- Closed: Terminal 14 is used for the master frequency reference.

Note: When the set value of Terminal 14 Selection (*H3-09*) is other than “1F” and the contact input is set for terminal 13/14 selection (*H1-__* = “1F”), a setting error (OPE3) occurs.

· External Fault (setting: “20-2F”)

Use this contact input to select how the inverter responds to an external fault.

External Fault Selection								Setting Result
Input Level Selection		Detection Method		External Fault Action				
N.O.	N.C.	Always	During Run	Ramp to Stop	Coast to Stop	Fast-stop	Alarm Only	
√		√		√				20
√		√			√			24
√		√				√		28
√		√					√	2C
√			√	√				22
√			√		√			26
√			√			√		2A
√			√				√	2E
	√	√		√				21
	√	√			√			25
	√	√				√		29
	√	√					√	2D
	√		√	√				23
	√		√		√			27
	√		√			√		2B
	√		√				√	2F

Notes:

1. N.O. = normally open contact; N.C. = normally closed contact
2. Setting “24” is the factory default.
3. Set up the external fault function according to the following tree:

V/f	V/f w/PG	Open Loop Vector	Flux Vector
-----	----------	------------------	-------------

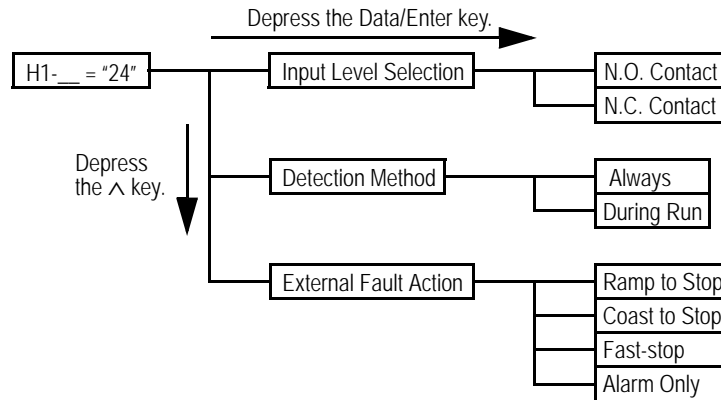

- PID Integral reset (Set value = 30)
 Open: PID Integral values are added.
 Closed: PID Integral value is set to zero.
- PID Control Integral Hold (Set value = 31) <1110>
 Closed: Integral value of the PID control is held.
- DC Injection Braking Command (setting: “60”)
 When a DC injection braking command is input while the inverter is stopped, DC injection braking operation is activated. When a run command or a jog command is input, DC injection braking is released to start operation (operation has priority).

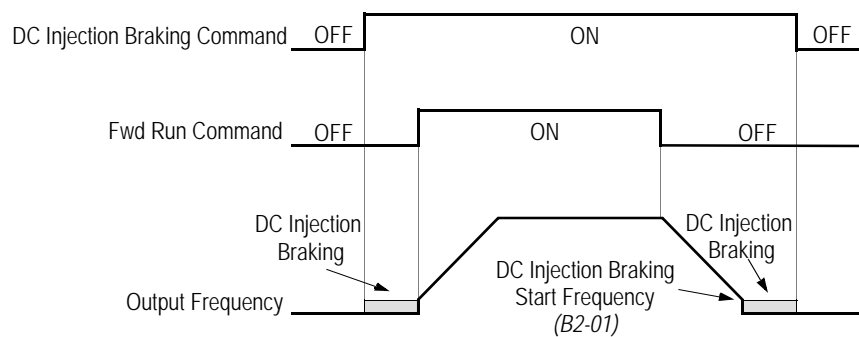
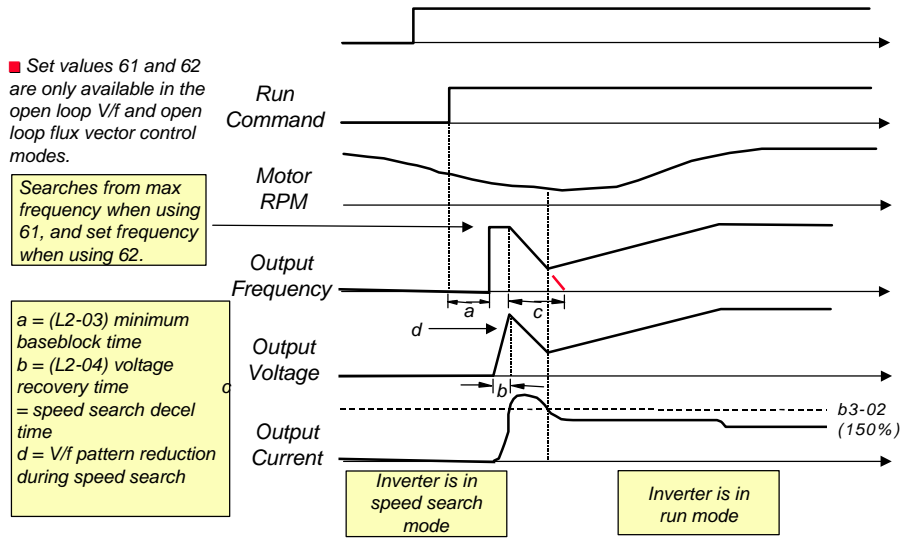

Figure 35 DC Injection Braking Contact Input Timing Diagram

V/f	V/f w/PG	Open Loop Vector	Flux Vector
-----	----------	------------------	-------------

·Speed Search 1 and Speed Search 2 (Set value = 61 and 62)



· Energy Save Mode (Set value = 63)

After the energy savings input is closed and the output frequency is equal to or greater than (b8-02) energy savings start frequency, the output voltage drops to the value in (b8-01) energy savings gain. The output voltage increases and decreases based on L2-04 (voltage recovery time).

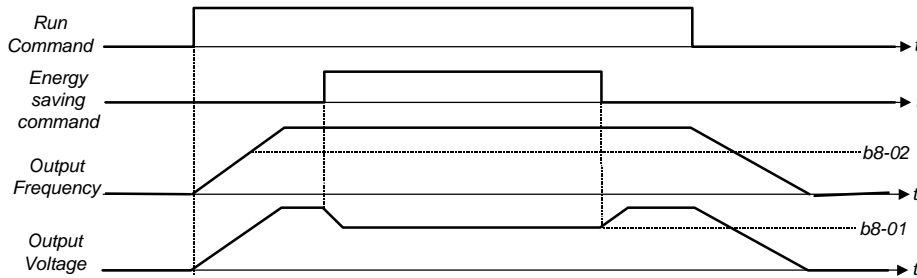

V/f	V/f w/PG	Open Loop Vector	Flux Vector
-----	----------	------------------	-------------

· Speed Search 3 (Set value = 64)

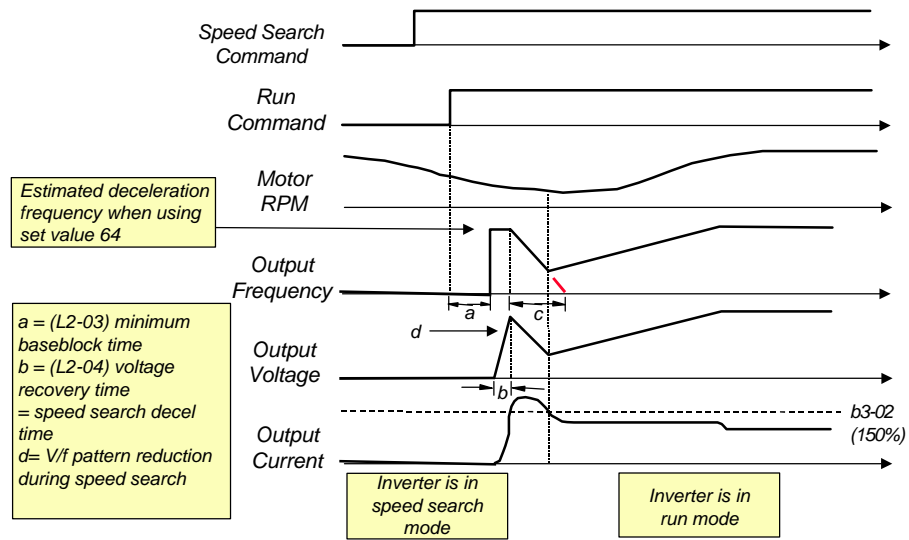

V/f	V/f w/PG	Open Loop Vector	Flux Vector
-----	----------	------------------	-------------

- KEB Ridethrough (settings: N.C. = “65”, N.O. = “66”)

In general applications, the Kinetic Energy Braking (KEB) control circuit attempts to maintain the DC bus voltage at an optimum level [$1.35 \times$ input voltage ($E1-01$)] during momentary power loss, by using load inertia to regenerate voltage back to the DC bus. The inverter decelerates at the fast-stop rate ($C1-09$), until power is restored, or until the time runs out and an undervoltage fault (UV) occurs. The larger the inertia, the longer the deceleration rate can be extended. If the inertia is small, then the inverter must decelerate quickly to regenerate voltage back to the DC bus, and thus the ride-through time is shorter. For most applications, set KEB Frequency Constant ($L2-06$) to “0” (factory default).

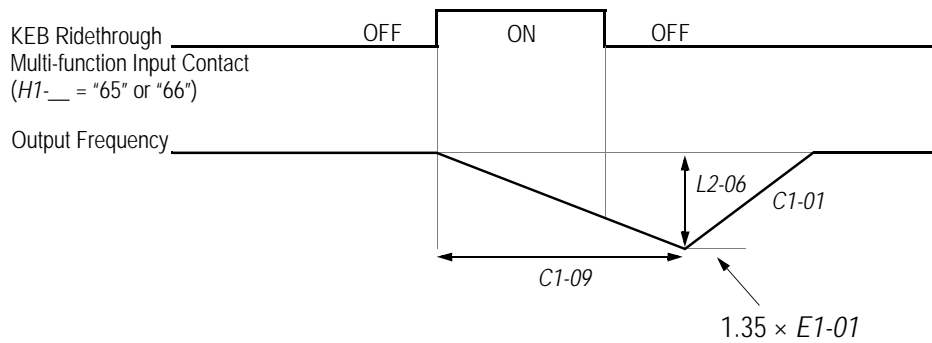

Figure 36 KEB Ridethrough Timing Diagram

Note: Larger model inverters (2022 and above, 4018 and above) require a separate uninterruptible power supply (UPS) for control power, in order for load inertia ride-through to be effective.

H2 Digital Outputs

The VS-616G5 has three multi-function contact outputs for the indication of various conditions, including frequency detection, speed agree, zero speed, overtorque detection, and many others. This section includes descriptions of these functions.

- H2-01 Multi-function Output 1 Selection (terminal 9, 10) Terminal 9 Sel
- H2-02 Multi-function Output 2 Selection (terminal 25, 27) Terminal 25 Sel
- H2-03 Multi-function Output 3 Selection (terminal 26, 27) Terminal 26 Sel

B	B	B	B
B	B	B	B
B	B	B	B

The following table lists the function selections for the multi-function contact outputs (terminals 9, 25 and 26), and indicates the control modes during which each function can be enabled.

H2-01 to 3 Setting	Function	Control Method (A1-02)				Reference Page
		V/f	V/f w/ PG	Open Loop Vector	Flux Vector	
0	During run 1 (factory default, H2-01)	√	√	√	√	
1	Zero-speed (factory default, H2-02)	√	√	√	√	
2	Frequency agree 1 (factory default, H2-03)	√	√	√	√	
3	Desired frequency agree 1	√	√	√	√	
4	Frequency detection 1	√	√	√	√	

H2-01 to 3 Setting	Function	Control Method (A1-02)				Reference Page
		V/f	V/f w/ PG	Open Loop Vector	Flux Vector	
5	Frequency detection 2	√	√	√	√	
6	Inverter ready	√	√	√	√	
7	DC bus undervoltage	√	√	√	√	
8	Baseblock 1	√	√	√	√	
9	Option reference	√	√	√	√	
A	Remote operation	√	√	√	√	
B	Torque detection 1 (N.O.)	√	√	√	√	
C	Loss of reference	√	√	√	√	
D	DB overheat	√	√	√	√	
E	Fault	√	√	√	√	
F	Not used	—	—	—	—	
10	Minor fault	√	√	√	√	
11	Reset command active	√	√	√	√	
12	Timer output	√	√	√	√	
13	Frequency agree 2	√	√	√	√	
14	Desired frequency agree 2	√	√	√	√	
15	Frequency detection 3	√	√	√	√	
16	Frequency detection 4	√	√	√	√	
17	Torque detection 1 (N.C.)	√	√	√	√	
18	Torque detection 2 (N.O.)	√	√	√	√	
19	Torque detection 2 (N.C.)	√	√	√	√	
1A	Reverse direction	√	√	√	√	
1B	Baseblock 2	√	√	√	√	
1C	Motor 2 Selection	√	√	√	√	
1D	Regenerating	—	—	—	√	
1E	Restart enabled	√	√	√	√	
1F	Overload (OL1)	√	√	√	√	
20	OH pre-alarm	√	√	√	√	
30	Current/torque limit	—	—	√	√	
31	Speed limit	—	—	—	√	
33	Zero servo completion	—	—	—	√	
37	During run 2	√	√	√	√	

- During Run (setting: “0”)
 - Closes when a run command is input, or when the inverter outputs voltage.
- Zero-speed (setting: “1”)
 - Closes when the inverter output frequency is less than the minimum output frequency (*E1-09*) during V/f control with PG feedback. Closes when the motor speed is less than the zero-speed level (*B2-01*) during flux vector control.

- Frequency Agree 1 (setting: “2”)

Closes whenever the output frequency “agrees” with the frequency reference, plus or minus the speed agree detection width (L4-02). This is effective during both forward *and* reverse operation.

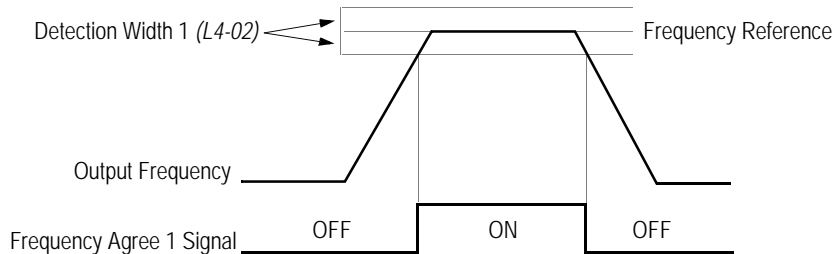

Figure 37 Frequency Agree Signal 1 Timing Diagram

- Desired Frequency Agree 1 (setting: “3”)

Closes whenever the output frequency “agrees” with the speed agree detection level (L4-01), plus or minus the speed agree detection width (L4-02). This is effective during both forward *and* reverse operation.

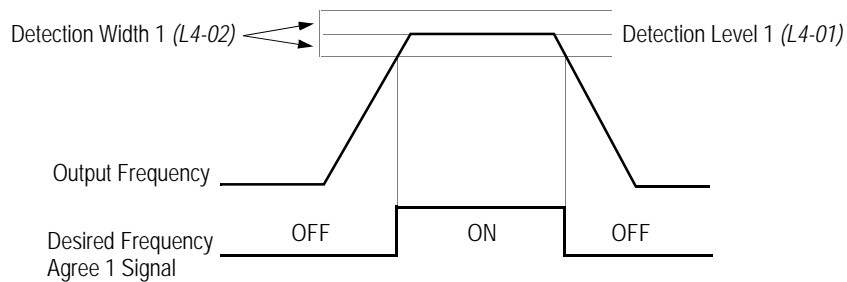

Figure 38 Desired Frequency Agree 1 Signal Timing Diagram

- Frequency Detection 1 (setting: “4”)

Closes whenever the output frequency is at or below the speed agree detection level (L4-01). During acceleration from below the detection level, the output frequency increases through the detection bandwidth (L4-02) before the contact opens again. This is effective during both forward and reverse operation.

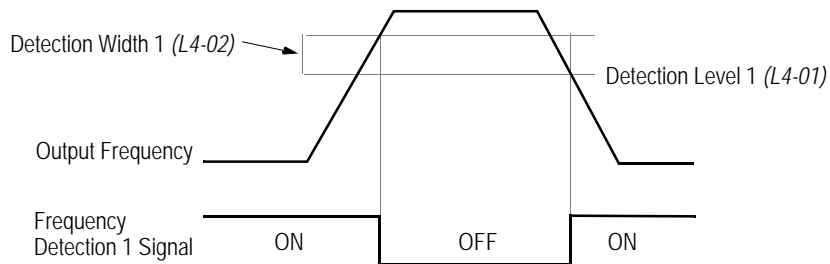

Figure 39 Frequency Detection 1 Signal Timing Diagram

- Frequency Detection 2 (setting: “5”)

Closes whenever the output frequency is at or above the speed agree detection level (*L4-01*). During deceleration from above the detection level, the output frequency decreases through the detection bandwidth (*L4-02*) before the contact opens again. This is effective during both forward *and* reverse operation.

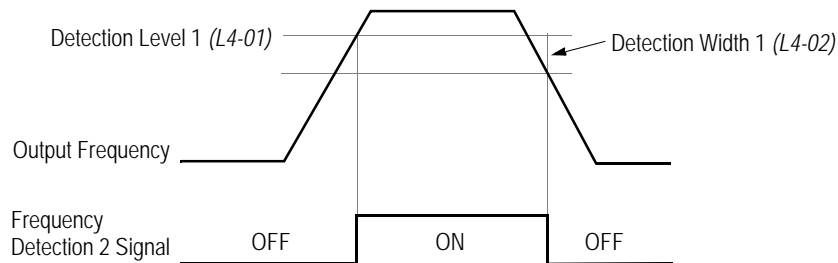

Figure 40 Frequency Detection 2 Signal Timing Diagram

- Inverter Ready (setting: “6”)

Closes when the inverter is ready for operation (no faults or alarms).
- DC Bus Undervoltage (setting: “7”)

Closes when the main circuit DC bus voltage or control circuit power supply is drops below the trip level, or when the main circuit magnetic contactor (MC) turns OFF.
- Baseblock 1 - N.O. (setting: “8”)

Closes when the inverter output shuts OFF.
- Frequency Reference Selection (setting: “9”)

Opens when the frequency reference is input from the control circuit terminals or an option.
 Closes when the frequency reference is input from the digital operator.
- Run Command Selection (setting: “A”)

Opens when run command is input from the control circuit terminals or an option.
 Closes when run command is input from the digital operator.
- Overtorque Detection 1 - N.O. (setting: “B”)

Closes during overtorque detection 1 (see section **L6, Overtorque Detection**, on page 113).

- Loss of Frequency Reference (setting: “C”)

Closes when frequency reference is reduced by 90% within 400ms. The inverter will respond according to the setting of reference loss selection (*L4-05*). After reference loss, if *L4-05* = “1”, then operation continues at 80% of the previous frequency reference, and the contact closes.

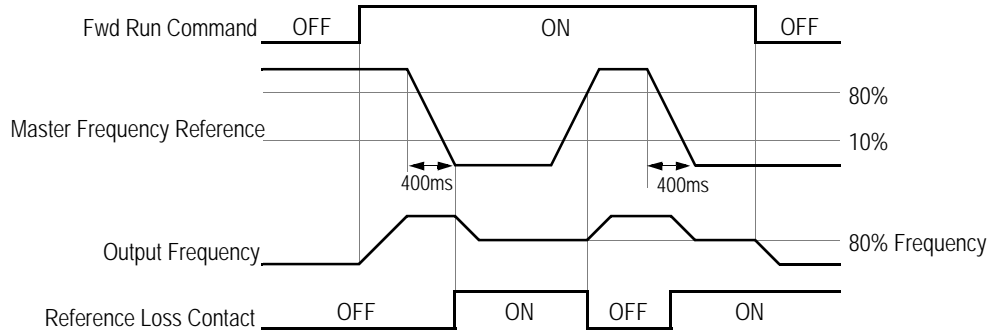

Figure 41 Reference Loss Timing Diagram

- Dynamic Braking Resistor Overheat (setting: “D”)

Closes during braking resistor overheating or a braking transistor fault.
- Fault (setting: “E”)

Closes when a fault occurs (except CPF00 and CPF01).
- Alarm (setting: “10”)

Closes while an alarm is displayed.
- Fault Reset (setting: “11”)

Closed while fault is being reset.
- Timer Output (setting: “12”)

Closes when timer contact input closes (after On-delay time elapses).
 Opens when timer contact input opens (after Off-delay time elapses).
- Frequency Agree 2 (setting: “13”)

Closes whenever the output frequency “agrees” with the frequency reference, plus or minus the speed agree detection width (*L4-04*). This is used for setting up an alternate detection width.

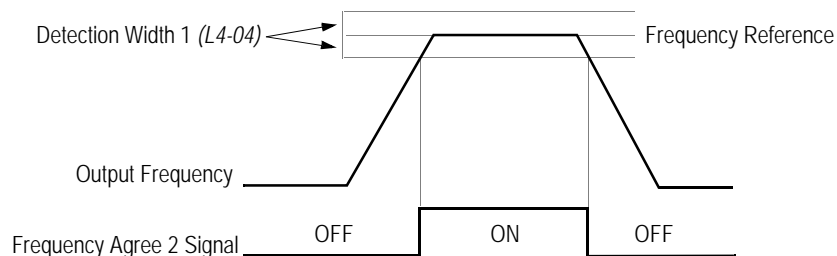

Figure 42 Frequency Agree Signal 2 Timing Diagram

- **Desired Frequency Agree 2 (setting: “14”)**
 Closes whenever the output frequency “agrees” with the speed agree detection level (L4-03), plus or minus the speed agree detection width (L4-04). Choose forward or reverse operation in L4-03.

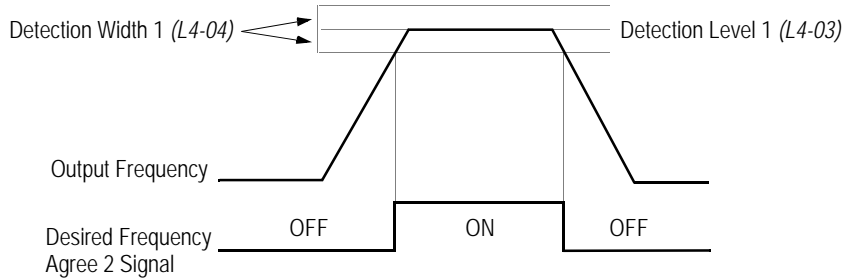

Figure 43 *Desired Frequency Agree 2 Signal Timing Diagram*

- **Frequency Detection 3 (setting: “15”)**
 Closes whenever the output frequency is at or below the speed agree detection level (L4-03). During acceleration from below the detection level, the output frequency increases through the detection bandwidth (L4-04) before the contact opens again. Choose forward or reverse operation in L4-03.

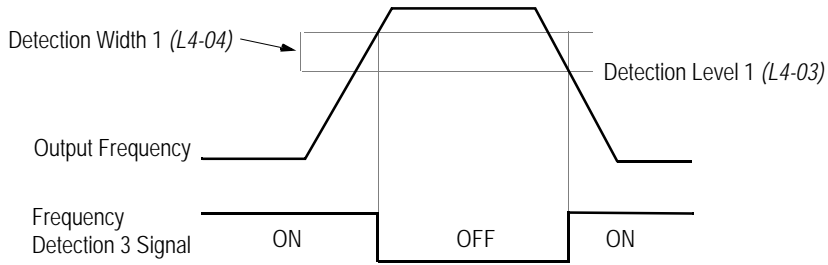

Figure 44 *Frequency Detection 3 Signal Timing Diagram*

- **Frequency Detection 4 (setting: “16”)**
 Closes whenever the output frequency is at or above the speed agree detection level (L4-03). During deceleration from above the detection level, the output frequency decreases through the detection bandwidth (L4-04) before the contact opens again. Choose forward or reverse operation in L4-03.

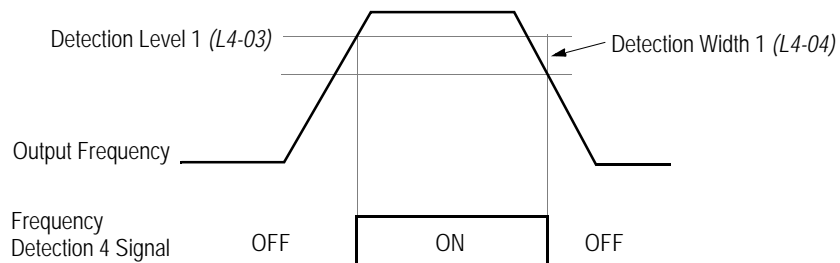

Figure 45 *Frequency Detection 2 Signal Timing Diagram*

- Overtorque Detection 1 - N.C. (setting: “17”)
Closes during overtorque detection 1 (see section *L6, Overtorque Detection*, on page 113).
- Overtorque Detection 2 - N.O. (setting: “18”)
Closes during overtorque detection 2 (see section *L6, Overtorque Detection*, on page 113).
- Overtorque Detection 2 - N.C. (setting: “19”)
Opens during overtorque detection 2 (see section *L6, Overtorque Detection*, on page 113).
- During Reverse Run (setting: “1A”)
Closes during a reverse run command.
- Baseblock 2 - N.C. (setting: “1B”)
Opens when the inverter output shuts OFF.
- Motor 2 Selection (setting: “1C”)
Closed when motor 2 is selected.
Motor 2 may be selected by using a multi-function digital input.
- Motoring/Regenerating Mode (setting: “1D”)
Closes during regenerative operation (flux vector control only).
- Automatic Restart (setting: “1E”)
Closes during automatic restart operation.
- OL1 Pre-alarm (setting: “1F”)
Closes when the motor-calculated electronic thermal overload value increases to 90% of the internal fault detection level.
- OH Pre-alarm (setting: “20”)
Closes when the heatsink temperature exceeds the overheat temperature level (*L8-02*), or when a multi-function contact input (*HI-__ = “B”*) closes.
- Current/Torque Limit (setting: “30”)
Closes during torque limit.
- Speed Limit (setting: “31”)
Closes when the speed limit level (*D5-03*) is reached during torque control (flux vector control).
- Zero-Servo Completion (setting: “33”)
Closes when zero-servo operation is completed.
- During Run 2 (setting: “37”)
Closes when a run command is input (does *not* close during baseblock, injection braking or initial excitation).

H3 Analog Inputs

The VS-616G5 has three analog inputs (two multi-function and one reference), for the external input of numerous references and limits, including frequency, torque, PID, and others. This section includes descriptions of these functions.

H3-01 Terminal 13 Signal Selection

Term 13 Signal

B	B	B	B
---	---	---	---

Selects the type of voltage signal input at terminal 13.

Setting	Description
0	0 to 10V input (<i>factory default</i>)
1	-10 to +10V input

The resolution of terminal 13 is 11 bit.

H3-02 Terminal 13 Reference % Gain

Terminal 13 Gain

B	B	B	B
---	---	---	---

Setting Range: 0.0 to 1000.0%

Factory Default: 100.0%

Sets the terminal 13 input gain level when the reference voltage is 10V.

H3-03 Terminal 13 Reference ±% Bias

Terminal 13 Bias

B	B	B	B
---	---	---	---

Setting Range: -100.0 to 100.0%

Factory Default: 0.0%

Sets the terminal 13 input bias level when the reference voltage is 0V.

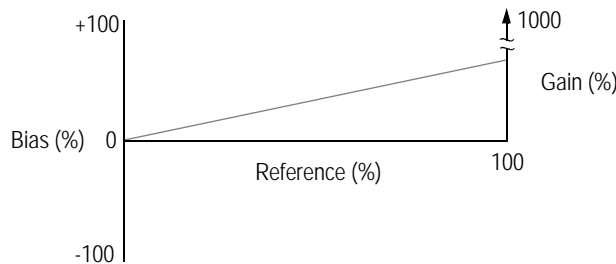

Figure 46 Analog Input Gain and Bias Adjustment

H3-04 Terminal 16 Signal Selection

Terminal 16 Sel

B	B	B	B
---	---	---	---

Selects the type of voltage signal input at terminal 16.

Setting	Description
0	0 to 10V input (<i>factory default</i>)
1	-10 to +10V input

The resolution of terminal 16 is 11 bit.

H3-05 Terminal 16 Multi-function Selection

Terminal 16 Sel

B	B	B	B
---	---	---	---

The following table lists the function selections for the multi-function analog inputs (terminals 14 and 16), and indicates the control modes during which each function can be enabled.

Setting	Function	Control Method (A1-02)				Setting Level
		V/f	V/f w/ PG	Open Loop Vector	Flux Vector	
0	Aux. Frequency Ref. (<i>factory default</i>)	√	√	√	√	±100% / ±10V
1	Frequency Gain	√	√	√	√	100% / 10V
2	Frequency Bias	√	√	√	√	±100% / ±10V
4	Voltage Bias	√	√	–	–	100% / 10V
5	Accel/Decel Change	√	√	√	√	100% / 1V
6	DC Injection Braking Current	√	√	√	–	100% / 10V
7	Overtorque Level	√	√	√	√	100% / 10V
8	Stall Prevention Level	√	√	–	–	100% / 10V
9	Reference Lower Limit	√	√	√	√	100% / 10V
A	Jump Frequency	√	√	√	√	100% / 10V
B	PID Feedback	√	√	√	√	±100% / ±10V
C	PID Reference Bias <1110>	√	√	√	√	10V/Fmax
D	Frequency Reference Bias 2 <1110>	√	√	√	√	10V/Fmax
10	Forward Torque Limit	–	–	√	√	100% / ±10V
11	Reverse Torque Limit	–	–	√	√	100% / ±10V
12	Regenerative Torque Limit	–	–	√	√	100% / ±10V
13	Torque Reference	–	–	–	√	±100% / ±10V
14	Torque Compensation	–	–	–	√	±100% / ±10V
15	Forward/Reverse Torque Limit	–	–	√	√	±100% / 10V
1F	Not Used	–	–	–	–	–

- Auxiliary Frequency Reference (setting: "0")
- Frequency Bias (setting: "2")
- PID Feedback (setting: "B")
- Torque Reference (setting: "13")
- Torque Compensation (setting: "14")

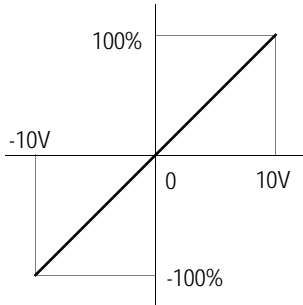

- Frequency Gain (setting: "1")
- Voltage Bias (setting: "4")
- DC Injection Braking Current (setting: "6")
- Overtorque Level (setting: "7")
- Reference Lower Limit (setting: "9")
- Jump Frequency (setting: "A")

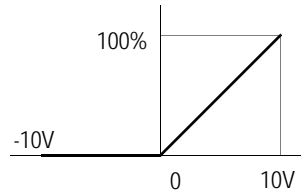

- Forward/Reverse Torque Limit (setting: "15")

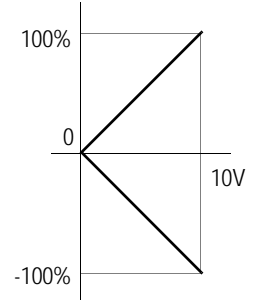

- Accel/Decel Change (setting: "5")

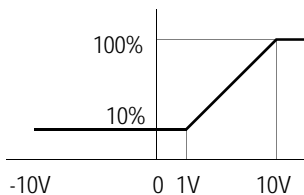

- Stall Prevention Level (setting: "8")

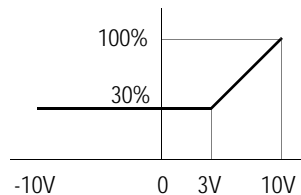

- Forward Torque Limit (setting: "10")
- Reverse Torque Limit (setting: "11")
- Regenerative Torque Limit (setting: "12")

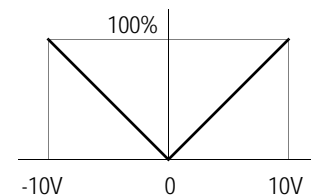

Figure 47 Multi-function Analog Input Selection

H3-06 Terminal 16 Reference % Gain

Terminal 16 Gain

B	B	B	B
---	---	---	---

Setting Range: 0.0 to 1000.0%
 Factory Default: 100.0%

Sets the terminal 16 input gain level when the reference voltage is 10V. See Figure 46, on page 95.

H3-07 Terminal 16 Reference ±% Bias

Terminal 16 Bias

B	B	B	B
---	---	---	---

Setting Range: -100.0 to 100.0%
 Factory Default: 0.0%

Sets the terminal 16 input bias level when the reference voltage is 0V. See Figure 46, on page 95.

H3-08 Terminal 14 Signal Selection

Term 14 Signal

A	A	A	A
---	---	---	---

Selects the type of signal input at terminal 14.

Setting	Description
0	0 to 10V input
1	-10 to +10V input
2	4 to 20mA (<i>factory default</i>)

The resolution of terminal 14 is 10 bit.

Note: To enable terminal 14 for a voltage signal (settings: “0” or “1”), cut jumper wire J1 on the control printed circuit board. J1 is located on the bottom left-hand corner of the control board directly behind terminal 13.

H3-09 Terminal 14 Multi-function Selection

Terminal 14 Sel

A	A	A	A
---	---	---	---

Selects the multi-function analog input function for terminal 14 (see Terminal 16 Multi-function Selection for details).

H3-10 Terminal 14 Reference % Gain

Terminal 14 Gain

A	A	A	A
---	---	---	---

Setting Range: 0.0 to 1000.0%
 Factory Default: 100.0%

Sets the terminal 14 input gain level when the reference current is 20mA. See Figure 46, on page 95.

H3-11 Terminal 14 Reference ±% Bias

Terminal 14 Bias

A	A	A	A
---	---	---	---

Setting Range: -100.0 to 100.0%
 Factory Default: 0.0%

Sets the terminal 14 input bias level when the reference current is 4mA. See Figure 46, on page 95.

H3-12 Analog Input Filter Time Constant

Filter Avg Time

A	A	A	A
---	---	---	---

Setting Range: 0.00 to 2.00s
 Factory Default: 0.00s

Sets up a delay filter time constant at terminals 13, 14 and 16. This filter inserts a delay between the time the command is input to the time it is received by the inverter.

H4 Analog Outputs

The VS-616G5 has two analog outputs, for the external monitoring of drive conditions such as output frequency, output current, PID feedback and others.

H4-01 Terminal 21 Analog Output Selection

Terminal 21 Sel

B	B	B	B
---	---	---	---

Selects the analog output monitors for terminal 21.

Setting	Description
1	Frequency reference
2	Output frequency (<i>factory default</i>)
3	Inverter output current
5	Motor speed
6	Output voltage
7	DC bus voltage
8	Output power
9	Torque reference (internal)
15	Terminal 13 input voltage level
16	Terminal 14 input voltage or current level
17	Terminal 16 input voltage level
18	Motor secondary current (Iq)
19	Motor excitation current (Id)
20	SFS output frequency
21	ASR input
22	ASR output
23	Speed deviation
24	PID feedback
26	Voltage reference (Vq output)
27	Voltage reference (Vd output)
32	ACR (q) Output
33	ACR (d) Output
36	PID Input Monitor <1110>
37	PID Output Monitor<1110>
38	PID Setpoint Monitor <1110>

The resolution of terminal 21 is 9 bit plus sign.

H4-02 Terminal 21 Analog Output Gain

Terminal 21 Gain

B	B	B	B
---	---	---	---

Setting Range: 0.00 to 2.50

Factory Default: 1.00

Sets the terminal 21 output gain for the analog output monitors. To obtain the output level, multiply the monitor output level by the gain value set in *H4-02*.

H4-03 Terminal 21 Analog Output Bias

Terminal 21 Bias

B	B	B	B
---	---	---	---

Setting Range: -10.0 to 10.0%
 Factory Default: 0.0%

Sets the terminal 21 output bias for the analog output monitors. To obtain the output level, multiply the monitor output level by the gain value set in *H4-02*, then add the bias value set in *H4-03*.

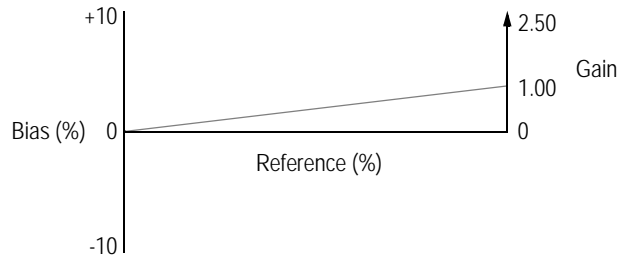

Figure 48 Analog Output Gain and Bias Adjustment

H4-04 Terminal 23 Analog Output Selection

Terminal 23 Sel

B	B	B	B
---	---	---	---

Selects the analog output monitors for terminal 23 (see Terminal 21 Analog Output Selection). The resolution of terminal 23 is 9 bit plus sign.

H4-05 Terminal 23 Analog Output Gain

Terminal 23 Gain

B	B	B	B
---	---	---	---

Setting Range: 0.00 to 2.50
 Factory Default: 1.00

Sets the terminal 23 output gain for the analog output monitors. To obtain the output level, multiply the monitor output level by the gain value set in *H4-05*. See Figure 48.

H4-06 Terminal 23 Analog Output Bias

Terminal 23 Bias

B	B	B	B
---	---	---	---

Setting Range: -10.0 to 10.0%
 Factory Default: 0.0%

Sets the terminal 23 output bias for the analog output monitors. To obtain the output level, multiply the monitor output level by the gain value set in *H4-05*, then add the bias value set in *H4-06*. See Figure 48.

H4-07 Analog Output Signal Selection

AO Level Select

B	B	B	B
---	---	---	---

Selects the type of voltage signal output at terminals 21 and 23.

Setting	Description
0	0 to 10V input (<i>factory default</i>)
1	-10 to +10V input

H5 Serial Communication Set-up

The inverter uses communication port 6CN to communicate via MODBUS protocol.

H5-01 Serial Communication Station Address

Serial Comm Adr

A	A	A	A
---	---	---	---

Setting Range: 0 to 1F

Factory Default: 1F

Selects a station address for identification of the inverter during serial communication.

H5-02 Serial Communication Baud Rate

Serial Baud Rate

A	A	A	A
---	---	---	---

Selects the baud rate at which the inverter serially communicates with external devices.

Setting	Description
0	1200 Baud per Second
1	2400 Baud per Second
2	4800 Baud per Second
3	9600 Baud per Second (<i>factory default</i>)
4	19200 Baud <1110>

H5-03 Serial Communication Parity Selection

Serial Com Sel

A	A	A	A
---	---	---	---

Selects the transmission parity for the 6CN MODBUS port.

Setting	Description
0	No parity (<i>factory default</i>)
1	Even parity
2	Odd parity

H5-04 Stopping Method After Communication Error *Serial Fault Sel*

A	A	A	A
---	---	---	---

Selects the stopping method after a transmission error is detected.

Setting	Description
0	Ramp to stop according to the time set in C1-02.
1	Fast-stop according to the time set in C1-09.
2	Coast to stop
3	Alarm only, continuous operation (<i>factory default</i>)

H5-05 MODBUS Time Out Detection

Serial Fault Dtct

A	A	A	A
---	---	---	---

H5-05 enables or disables the MODBUS time out detection function. After initial communication begins, if communication is interrupted for longer than 2 seconds, then a communication fault will occur.

During a communication fault, the following fault code will be displayed: “CE Memobus Com Err”.

Setting	Description
0	Disabled - Time out detection is disabled.
1	<i>Enabled - Time out detection is enabled.</i>

L Protection Parameters

L1 Motor Overload

The VS-616G5 protects against motor overload with a UL-recognized, built-in electronic thermal overload function.

L1-01 Motor Protection Fault Selection (OL1)

MOL Fault Select

B	B	B	B
---	---	---	---

Selects whether motor overload protection is provided.

Setting	Description
0	Motor overload detection is disabled.
1	Motor overload detection is enabled, motor coasts to stop (<i>factory default</i>).

The electronic thermal overload function estimates motor temperature, based on inverter output current and time, to protect the motor from overheating. When the electronic thermal overload relay is activated, an “OL1” error occurs, shutting OFF the inverter output and preventing excessive overheating in the motor. As long as the inverter is powered up, it continues to calculate the motor temperature.

When operating with one inverter connected to one motor, an external thermal relay is not needed.

When operating several motors with one inverter, install a thermal relay on each motor. In this case, set parameter *L1-01* to “0”.

L1-02 Motor Protection Time Constant

MOL Time Const

B	B	B	B
---	---	---	---

Setting Range: 0.1 to 20.0 minutes <1110>
 Factory Default: 8.0 minutes

Sets the amount of time that the motor withstands 150% overload, when the motor is operated continuously at rated current. This value should be set according to the overload resistance of motors used.

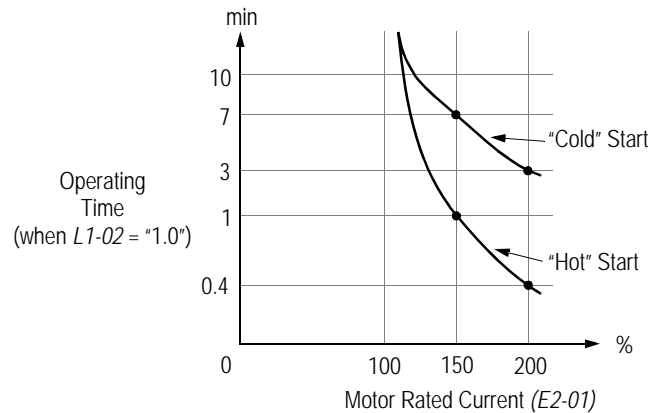

Figure 49 Electronic Thermal Overload Curve

Notes:

1. If the motor is running at 100% output current or less, the electronic thermal overload relay will *not* trip. (continued next page)
2. If the motor is run continuously at 150% output current, the electronic thermal overload relay will trip after one minute if the motor is started “hot”, and after eight minutes if the motor is started “cold”.

L2 Power Loss Ridethrough

When momentary power loss occurs, operation can restart automatically, according to the setting of the following parameters.

L2-01 Momentary Power Loss Ridethrough Selection

PwrL Selection

B	B	B	B
---	---	---	---

Selects whether the inverter stops when power loss is detected or “rides through” a momentary power loss. When ridethrough operation is selected, speed search starts from the current output frequency.

Setting	Description
0	Momentary power loss ridethrough is disabled (<i>factory default</i>). When momentary power loss is detected, a fault contact trips, stopping the inverter.
1	Momentary power loss ridethrough is enabled, for the time set in <i>L2-02</i> . When momentary power loss is detected, a fault contact does <i>not</i> trip. If power is not restored within the time set in <i>L2-02</i> , a fault contact trips, stopping the inverter.

Setting	Description
2	Momentary power loss ridethrough is enabled, within the control logic time, regardless of the time set in L2-02. The control logic time differs depending on inverter capacity.

L2-02 *Momentary Power Loss Ridethrough Time*

PwrL RideThru t

B	B	B	B
---	---	---	---

Setting Range: 0.0 to 2.0s

Factory Default: Inverter model dependent

Sets the ridethrough time allowed before the inverter trips, after momentary power loss. This setting is activated when L2-01 is set to “1”. If power is restored within this time, operation restarts automatically. If power is not restored within this time, a fault contact trips, stopping the inverter.

L2-03 Minimum Baseblock Time *PwrL Baseblock t*

B	B	B	B
---	---	---	---

Setting Range: 0.1 to 5.0s
 Factory Default: Inverter model dependent

After momentary power loss has occurred, the motor may have residual voltage. This can cause excess current to be drawn by the motor when operation restarts, and can trip the inverter. The minimum baseblock time allows the inverter to wait for this residual voltage to dissipate before restarting. This is only effective when *L2-02* is set to “1” or “2”.

After momentary power loss:

- If the minimum baseblock time (*L2-03*) is greater than the power loss ridethrough time (*L2-02* or control logic time), then operation restarts after the minimum baseblock time elapses.
- If the minimum baseblock time is less than the power loss ridethrough time, then operation restarts after the power loss ridethrough time elapses.

L2-04 Voltage Recovery Time *PwrL V/f Ramp t*

A	A	A	A
---	---	---	---

Setting Range: 0.0 to 5.0s
 Factory Default: Inverter model dependent

When operation restarts after momentary power loss, speed search is activated in order to detect the motor speed. After speed search is complete, the time for the output voltage to increase to its previous level (before power loss) is defined by the voltage recovery time.

L2-05 Undervoltage Detection Level *PUV Det Level*

A	A	A	A
---	---	---	---

Setting Range: 150 to 210V (230V class), 300 to 420V (460V class), 431 to 603V (575V class)
 Factory Default: 190V (230V class), 380V (460V class), 546V (575V class)

Sets the inverter main circuit DC bus undervoltage level.

When setting this value less than the factory default, it is necessary to install an AC reactor on the input side. The AC reactor reduces peak current input to the inverter and smooths out the DC bus current ripple when operating at low voltages.

L2-06 Kinetic Energy Braking Frequency Constant *KEB Frequency*

A	A	A	A
---	---	---	---

Setting Range: 0 to 100%
 Factory Default: 0%

This parameter allows for setting the load inertia ridethrough level, as a percentage of output frequency. This setting is used in conjunction with multi-function contact inputs set for KEB ridethrough (*H1-__* = “65” or “66”), after momentary power loss. When the KEB frequency constant is set to “0”, KEB ridethrough functions as normal, to maintain a controlled deceleration rate for the longest time possible, during a momentary power loss (see section H1, Digital Inputs, on page 76 for more details). When the KEB frequency constant is set to any value other than “0”, KEB ridethrough for systems use is enabled.

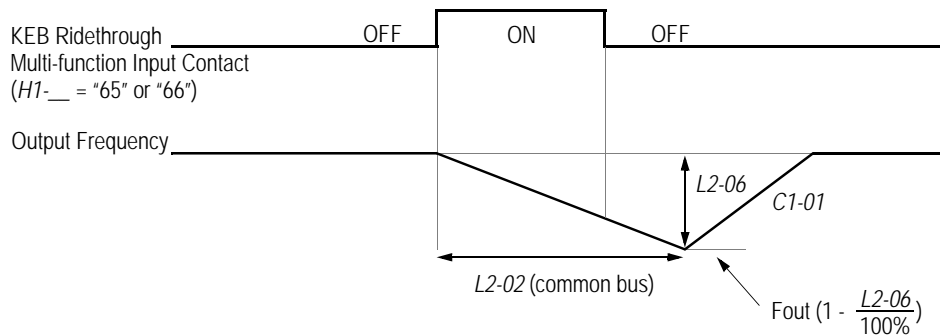

Figure 50 KEB Ridethrough Timing Diagram

In system applications requiring multiple drives with a common DC bus, KEB ride-through functions differently. The inverter decelerates from the output frequency to the KEB frequency level, according to the momentary power loss ridethrough time (*L2-02*). The KEB frequency constant (*L2-06*) is set according to the following equation:

$$\text{KEB Frequency Level} = \text{Output Frequency} \left(1 - \frac{L2-06}{100\%} \right)$$

This method is ideal when helper drives are being used on a film line, and a loss of power might cause a line break. This method will allow synchronized deceleration for all of the common-bus drives, to prevent speed deviation and thus a possible line break. If power is restored within the recovery time (*L2-02*), then the inverter accelerates to the previous frequency reference according to acceleration time 1 (*C1-01*).

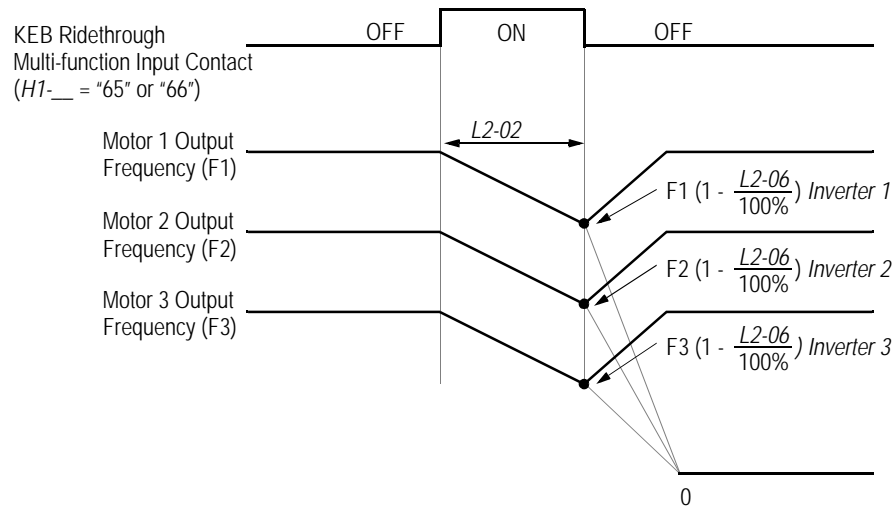

Figure 51 KEB Ridethrough - Common DC Bus Applications

Note: Enabling KEB ridethrough overrides the momentary power loss ride-through selection (L2-01).

L3 Stall Prevention/Current Limit

This function automatically adjusts the output frequency, acceleration and/or deceleration rates in order to continue operation without tripping or “stalling” the inverter.

L3-01 Stall Prevention Selection During Acceleration StallP Accel Sel

B	B	B	–
---	---	---	---

Enables/disables stall prevention/current limit during acceleration.

Setting	Description
0	Stall prevention/current limit during acceleration is disabled. The inverter increases the output frequency at the set acceleration rate. If the acceleration rate is too fast for the load condition, the inverter may trip on overcurrent (OC) or overload (OL).
1	Stall prevention/current limit during acceleration is enabled (<i>factory default</i>). The acceleration rate is automatically reduced according to motor current to prevent stalling during acceleration. The acceleration time may be longer than the set value (C1-01).
2	Stall prevention/current limit during acceleration is enabled, with an <i>intelligent</i> acceleration mode. By monitoring motor current, the acceleration rate is automatically adjusted so that acceleration can be completed in the shortest amount of time, regardless of the set acceleration time.

L3-02 Stall Prevention Level During Acceleration

StallP Accel Lvl

B	B	B	—
---	---	---	---

Setting Range: 0 to 200%
 Factory Default: 150%

The stall prevention/current limit level during acceleration is set as a percentage of inverter rated current. A setting of 200% disables current limit during acceleration. During acceleration, if the output current exceeds this current limit level (L3-02), acceleration stops and frequency is maintained. When the output current decreases below this current limit level (L3-02), acceleration restarts.

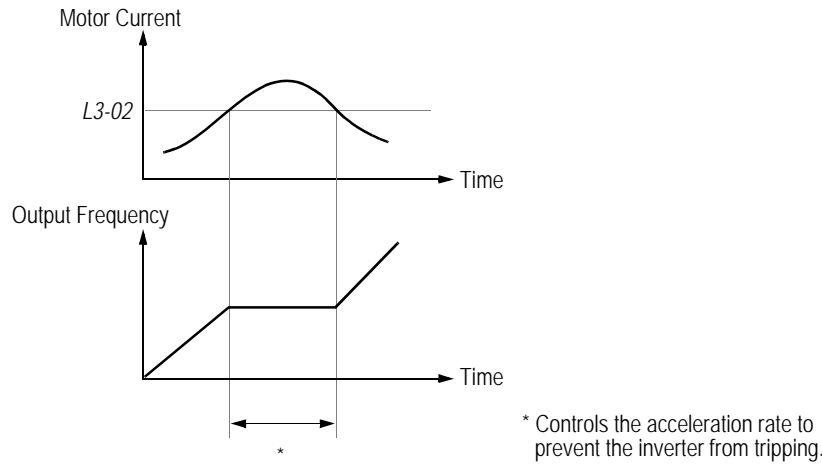

Figure 52 Stall Prevention/Current Limit During Acceleration

L3-03 Stall Prevention Limit (constant output area)

StallP CHP Level

A	A	A	—
---	---	---	---

When a motor is used in the constant output area (constant HP), output frequency \geq max. voltage output frequency (E1-06). In this area, the stall prevention/current limit level during acceleration is automatically reduced for smoother acceleration. This parameter limits the stall prevention/current limit level during acceleration in the constant output area so that it does not decrease unnecessarily. The current limit level during acceleration is changed according to the following equation:

$$\boxed{\text{Current Limit Level During Accel in Constant Output Area}} = \boxed{\text{Current Limit Level During Acceleration (L3-02)}} \times \frac{\text{Max. Voltage Output Frequency (E1-06)}}{\text{Output Frequency}}$$

L3-04 Stall Prevention Selection During Deceleration StallP Decel Sel

B	B	B	B
---	---	---	---

If deceleration times are set too short for load conditions, the inverter automatically extends the deceleration time according to the main circuit DC bus voltage level. When using an optional braking resistor for the VS-616G5, set parameter L3-04 to "0".

Setting	Description
0	Stall prevention during deceleration is disabled. An excessively short deceleration time will generate an overvoltage fault (OV), and the inverter will stop.
1	Stall prevention during deceleration is enabled (<i>factory default</i>). The DC bus voltage level is monitored, and the deceleration rate is automatically extended to prevent an overvoltage condition. This deceleration rate may be longer than the set value (C1-02).
2	Stall prevention during deceleration is enabled, with an <i>intelligent</i> deceleration mode. By monitoring DC bus voltage, the deceleration rate is automatically adjusted so that deceleration can be completed in the shortest amount of time, regardless of the set deceleration time.
3	Overvoltage (OV) countermeasure during deceleration (with braking resistor installed). Improves stall prevention during deceleration. Overvoltage (OV) sometimes occurs even under settings 1 or 2 above. The rising of the DC bus voltage is limited during fast deceleration of the motor. This feature allows a faster than normal decel time. Note: When in vector mode setting 3 cannot be used with braking resistor and with stall prevention.

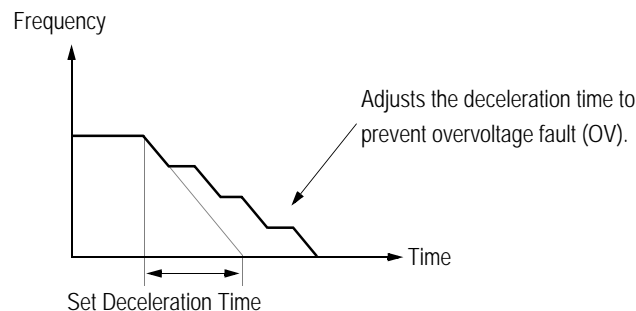

Figure 53 Stall Prevention During Deceleration

Note: Intelligent stall prevention during deceleration (L3-04 = "2") cannot be set in the vector control modes (when A1-02 = "2" or "3").

L3-05 Stall Prevention Selection During Running

StallP Run Sel

B	B	-	-
---	---	---	---

Sets a function to prevent stalling during an overload condition while running at constant speed.

Setting	Description
0	Stall prevention/current limit during running is disabled. An excessively short deceleration time will generate an overvoltage fault (OV), and the inverter will stop.
1	Stall prevention/current limit during running is enabled (<i>factory default</i>). When the inverter output current exceeds the current limit level (L3-06) for more than 100ms during speed agree, the output frequency is decreased according to deceleration time 1 (C1-02), and this can prevent stalling. When the load condition is stabilized, the inverter accelerates to the previous frequency.
2	Stall prevention/current limit during running is enabled as in setting "1", however the output frequency is decreased according to deceleration time 2 (C1-04).

L3-06 Stall Prevention Level During Running

StallP Run Lvl

B	B	-	-
---	---	---	---

Setting Range: 30 to 200%

Factory Default: 160%

The stall prevention/current limit level during running is set as a percentage of inverter rated current. A setting of 200% disables current limit during running. During speed agree, if the output current exceeds this current limit level during running, then deceleration starts.

When the output current exceeds this current limit level (L3-06), deceleration continues. When the output current decreases below this current limit level (L3-06), acceleration starts, up to the set frequency.

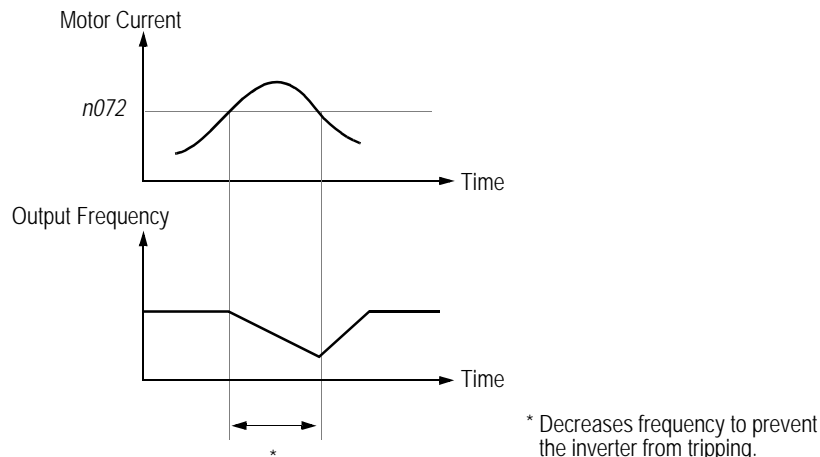

Figure 54 Stall Prevention/Current Limit During Running

L4 Reference Detection

The VS-616G5 utilizes three different functions for detecting output frequency:

- When frequency agree is enabled at the multi-function contact outputs ($H2-__ = "2"$ or $"13"$), the contact closes whenever the output frequency “agrees” with the frequency reference, plus or minus the speed agree detection width.
- When desired frequency agree is enabled at the multi-function contact outputs ($H2-__ = "3"$ or $"14"$), the contact closes whenever the output frequency “agrees” with the speed agree detection level, plus or minus the speed agree detection width.
- When frequency detection is enabled at the multi-function contact outputs ($H2-__ = "4"$, $"5"$, $"15"$ or $"16"$), the contact closes whenever the output frequency is less than or more than the speed agree detection level, depending on which detection is selected.

Refer to section **H2, Digital Outputs** on page 88, for more detailed information on setting these functions.

L4-01 Speed Agree Detection Level (without sign) *Spd Agree Level*

B	B	B	B
---	---	---	---

Setting Range: 0.0 to 400.0Hz
 Factory Default: 0.0Hz

Sets the detection level for the desired frequency agree 1 and frequency detection 1 and 2 functions. The set detection level is effective during both FWD and REV operation.

L4-02 Speed Agree Detection Width *Spd Agree Width*

B	B	B	B
---	---	---	---

Setting Range: 0.0 to 20.0Hz
 Factory Default: 2.0Hz

Sets the detection width for frequency and desired frequency agree 1 and frequency detection 1 and 2 functions.

L4-03 Speed Agree Detection Level (with sign) *Spd Agree Lvl+-*

A	A	A	A
---	---	---	---

Setting Range: 0.0 to ± 400.0 Hz
 Factory Default: 0.0Hz

Sets the detection level for the desired frequency agree 2 and frequency detection 3 and 4 functions. The set detection level is effective during either FWD or REV operation, depending on the set detection level (positive value for FWD operation, negative value for REV operation).

L4-04 Speed Agree Detection Width *Spd Agree Width+-*

A	A	A	A
---	---	---	---

Setting Range: 0.0 to 20.0Hz
 Factory Default: 2.0Hz

Sets the detection width for frequency and desired frequency agree 2 and frequency detection 3 and 4 functions.

L4-05 Operation When Frequency Reference Loss *Ref Loss Sel*

A	A	A	A
---	---	---	---

Selects operation when the frequency reference from the control circuit terminal is reduced by 90% within 400ms.

Setting	Description
0	Stop (<i>factory default</i>).
1	Run at 80% of the previous frequency reference.

L5 Automatic Restart

After a fault occurs, the inverter and its fault detection circuit can be reset. The automatic restart function allows the inverter to continue operation after certain faults.

L5-01 Number of Automatic Restart Attempts *Num of Restarts*

B	B	B	B
---	---	---	---

Setting Range: 0 to 10
 Factory Default: 0

Sets the number of automatic restart attempts. Setting to “0” disables this function.

Automatic Restart Operation

- When a fault is detected, the inverter output shuts OFF for the minimum baseblock time (*L2-03*). The digital operator displays the fault while the inverter output is shut OFF.
- While the minimum baseblock time elapses, the fault is reset automatically and speed search starts from the previous output frequency before the fault occurred.
- When the total number of faults exceeds the number of automatic restart attempts, the faults are *not* reset automatically and the inverter output remains OFF. At this time, a fault contact output is activated.

The inverter can be set to automatically restart after the following faults occur:

- Overcurrent (OC)
- Overvoltage (OV)
- Undervoltage PUV (UV1)
- Ground fault (GF)
- Regenerative transistor fault (rr)

However, automatic restart is not available for the following faults:

- | | |
|--------------------------------------|-----------------------------------|
| · Control circuit undervoltage (UV2) | · Excessive speed deviation (DEV) |
| · MC answer-back fault (UV3) | · PG disconnection (PGO) |
| · Load short-circuit (SC) | · Parameter setting error (OPR) |
| · Heatsink overheat (OH) | · Communication error (CE) |
| · Run command fault (EF) | · External fault (EF3 to EF8) |
| · Overspeed (OS) | |

The number of restart attempts is reset to 0 when:

- A fault does not occur for more than 10 minutes after restart.
- A fault reset command is input from the control circuit terminal or the digital operator.
- Power is cycled.

L5-02 Automatic Restart Operation Selection

Restart Sel

B	B	B	B
---	---	---	---

Selects whether a fault contact output is activated during automatic restart.

Setting	Description
0	No fault relay (<i>factory default</i>)
1	Fault relay active

L6 Torque Detection

The overtorque detection circuit activates when the motor load causes the motor current (or torque during vector control) to exceed the overtorque detection level (**L6-02**). When an overtorque condition is detected, alarm signals are sent to multi-function output terminals 9, 25 and 26.

To output an overtorque detection signal, select torque detection 1 at either of the multi-function contact outputs (**H2-__** = “B” or “17”). Refer to section **H2, Digital Outputs** on page 88, for more details.

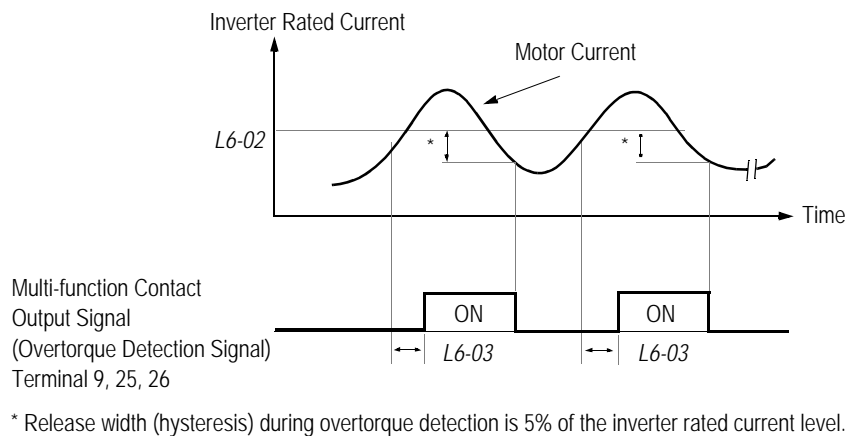

Figure 55 Overtorque Characteristics Timing Diagram

L6-01 Overtorque Detection 1 Selection

Torq Det 1 Sel

B	B	B	B
---	---	---	---

Activates overtorque detection, and selects whether detection generates an alarm or a fault.

Setting	Description
0	Overtorque detection is disabled (<i>factory default</i>).
1	Overtorque detection is enabled whenever at the speed agree level (when inverter is not accelerating or decelerating). Continue running after detection (OL3 alarm).
2	Overtorque detection is enabled always. Continue running after detection (OL3 alarm).
3	Overtorque detection is enabled whenever at the speed agree level. Coast to a stop after detection (OL3 fault).
4	Overtorque detection is enabled always. Coast to a stop after detection (OL3 fault).

L6-01 Notes:

- To detect torque during acceleration or deceleration, set to “2” or “4”.
- To continue operation after overtorque detection, set to “1” or “2”. During detection, the digital operator displays an “OL3” alarm (blinking).
- To stop the inverter after an overtorque detection fault, set to “3” or “4”. During detection, the digital operator displays an “OL3” fault.

L6-02 Overtorque Detection 1 Level *Torq Det 1 Lvl*

B	B	B	B
---	---	---	---

Setting Range: 0 to 300%
 Factory Default: 150%

Sets the overtorque detection level as a percentage of inverter rated current, during V/f control, and motor rated torque, during vector control.

L6-03 Overtorque Detection 1 Time *Torq Det 1 Time*

B	B	B	B
---	---	---	---

Setting Range: 0.0 to 10.0s
 Factory Default: 0.1s

The overtorque detection delay time inserts a delay, between the time motor current (or torque) exceeds the overtorque detection level (*L6-02*) and when the overtorque detection function is enabled. The digital operator then displays “OL3”.

L6-04 Overtorque Detection 2 Selection *Torq Det 2 Sel*

A	A	A	A
---	---	---	---

Activates overtorque detection 2, and selects whether detection generates an alarm or a fault.

Setting	Description
0	Overtorque detection is disabled (<i>factory default</i>).
1	Overtorque detection is enabled whenever at the speed agree level (when inverter is not accelerating or decelerating). Continue running after detection (OL4 alarm).
2	Overtorque detection is enabled always. Continue running after detection (OL4 alarm).
3	Overtorque detection is enabled whenever at the speed agree level. Coast to a stop after detection (OL4 fault).
4	Overtorque detection is enabled always. Coast to a stop after detection (OL4 fault).

Overtorque detection 2 functions the same as overtorque detection 1 (*L6-01*), except that “OL4” is displayed on the digital operator instead. This function is used when two types of detection are output to the multi-function output terminals.

L6-05 Overtorque Detection 2 Level *Torq Det 2 Lvl*

A	A	A	A
---	---	---	---

Setting Range: 0 to 300%
 Factory Default: 150%

Sets the second overtorque detection level as a percentage of inverter rated current, during V/f control, and motor rated torque, during vector control.

L6-06 Overtorque Detection 2 Time *Torq Det 2 Time*

A	A	A	A
---	---	---	---

Setting Range: 0.0 to 10.0s
 Factory Default: 0.1s

The overtorque detection 2 delay time inserts a delay, between the time motor current (or torque) exceeds the overtorque detection level (*L6-05*) and when the second overtorque detection function is enabled. The digital operator then displays “OL3”.

L7 Torque Limit

The torque limit function limits the amount of motor torque in all four quadrants of vector control operation:

- Forward Motoring
- Forward Regenerating
- Reverse Motoring
- Reverse Regenerating

Torque limit is activated in both the speed and torque control modes.

L7-01 Forward Torque Limit *Torq Limit Fwd*

-	-	B	B
---	---	---	---

Setting Range: 0 to 300%
 Factory Default: 200%

Sets the motoring side torque limit value during FWD run.

L7-02 Reverse Torque Limit *Torq Limit Rev*

-	-	B	B
---	---	---	---

Setting Range: 0 to 300%
 Factory Default: 200%

Sets the motoring side torque limit value during REV run.

L7-03 Regenerative Forward Torque Limit *Torq Lmt Fwd Rgn*

-	-	B	B
---	---	---	---

Setting Range: 0 to 300%
 Factory Default: 200%

Sets the regenerating side torque limit value during FWD run.

L7-04 Regenerative Reverse Torque Limit *Torq Lmt Rev Rgn*

-	-	B	B
---	---	---	---

Setting Range: 0 to 300%
 Factory Default: 200%

Sets the regenerating side torque limit value during REV run.

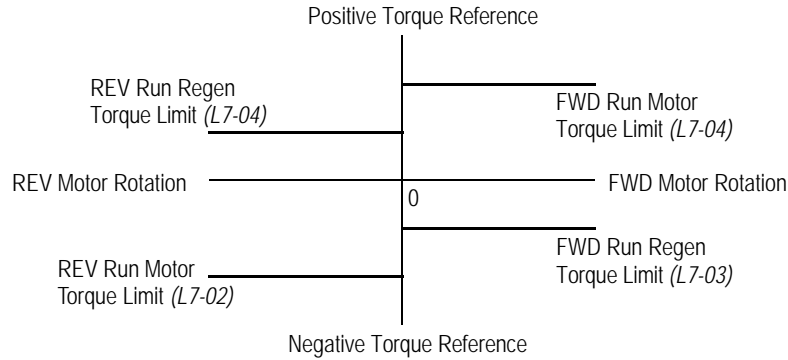

Figure 56 Torque Limit - 4 Quadrant Operation

L8 Hardware Protection

The VS-616-G5 comes equipped with a number of built-in functions designed to protect the inverter and its components from damage. This section describes the set-up of these functions.

L8-01 Protection Selection for Internal DB Resistor *DB Resistor Prot*

B	B	B	B
---	---	---	---

When a Yaskawa dynamic braking resistor is used, protection against overheating is enabled with this function. The duty cycle of the braking resistor is monitored in software so that it does not exceed 3%.

Setting	Description
0	DB resistor overheating protection is not provided (<i>factory default</i>).
1	DB resistor overheating protection is provided.

If the duty cycle exceeds 3%, a DB overheating fault (RH) occurs, and the inverter coasts to stop.

L8-02 OH Pre-Alarm Level *OH Pre-Alarm Lvl*

A	A	A	A
---	---	---	---

Setting Range: 0 to 100°C
 Factory Default: 100°C

Sets the heatsink temperature level for protection against overheating (OH).

L8-03 Stopping Method Selection After OH Pre-Alarm *OH Pre-Alarm Sel*

A	A	A	A
---	---	---	---

Selects the stopping method when heatsink overheat is detected.

Setting	Description
0	Ramp to stop according to <i>C1-02</i> setting.
1	Coast to stop
2	Ramp to stop according to <i>C1-09</i> setting (fast-stop).
3	Operation continues, alarm only (<i>factory default</i>).

L8-05 Input Phase Loss Protection

Ph Loss In Sel

A	A	A	A
---	---	---	---

The input phase loss detection circuit monitors the DC bus current ripple and activates when the one of the input phases are lost. The detection circuit calculates the maximum and minimum values of the DC bus voltage in one second intervals, and compares the difference (ΔV) between these values with an internal detection level. If ΔV reaches or exceeds the detection level, then after 0.5 second, input phase loss is detected; a PF fault occurs, and the motor coasts to stop.

Setting	Description
0	Input phase loss protection is disabled (<i>factory default</i>).
1	Input phase loss protection is enabled.

Input phase loss detection is disabled in the following cases:

- A Stop command is input.
- Magnetic Contactor (MC) shuts OFF.
- CPU A/D converter fault (CPF5).
- During deceleration.
- Output current $\leq 30\%$ of Inverter rated current.

L8-07 Output Phase Loss Protection

Ph Loss Out Sel

A	A	A	A
---	---	---	---

The output phase loss detection circuit monitors the DCCT and activates when one of the output phases are lost. The detection circuit calculates the RMS current value (I_{RMS}) for each of the phases and compares it with an internal output detection level. If I_{RMS} decreases to or below the detection level for 10 seconds, an output phase loss (LF) fault occurs, and the motor coasts to stop.

Setting	Description
0	Output phase loss protection is disabled (<i>factory default</i>).
1	Output phase loss protection is enabled.

L8-10 Ground Fault Protection

Ground Fault Sel

A	A	A	A
---	---	---	---

The ground fault detection circuit monitors the output current and activates when one of the output phases is connected to ground.
 A ground fault will occur when the inverter output grounding current has exceeded 50% of the inverter rated current.
 When a ground fault condition occurs, the following fault code will be displayed: “GF Ground Fault”.

Setting	Description
0	Disabled - Ground fault protection is disabled
1	Enabled - Ground fault protection is enabled. (<i>factory default</i>).

L8-17 IGBT Protection at Low Speed

Prctct@L-Spd

A	A	A	—
---	---	---	---

This parameter assists in protecting the IGBT from overheating of the transistor junction when the output current is high and the output frequency is low. The settings are as follows:

Setting	Description
0	Conventional Method (No change in carrier), inverter relies on L8-19 protection (same as 1042 software).
1	<i>Lower fc - When output current is greater than 100%, and output frequency is less than or equal to 10Hz, the carrier frequency is automatically decreased to the L8-18 setting (between 8 and 2 kHz depending on model). The carrier will automatically return to the normal value after the load is reduced. (factory default)</i>
2	Short term OL2 - OL occurs in 2 seconds when at low output frequencies (6Hz or less) and in hard current limit.
3	I-Limit=150% - Current limit is 150% of inverter rated current. The IGBT junction temperature should be below any critical level provided the output current is less than 150%. <1110>

L8-19 OL2 Characteristics at Low speed <1110>

OL2 Chara@L-Spd

A	A	A	A
---	---	---	---

This parameter allows the selection of normal or fast OL2 protection below 6 or 10 Hz. It is recommended that this parameter be enabled at all times. In some instances fast OL2 protection (L8-19=1) may not be desired, such as when operating in flux vector at zero speed. If L8-19 is set to 0 (disabled) L8-17 must be set to 1,2, or 3.

Setting	Description
0	Disabled -OL2 protection is disabled at low speed. This OL2 protection is the same at high speed and low speed. <i>(factory default).</i>
1	Enabled - A current limiting function is performed at low speed, the inverter OL2 protection responds quickly at 6 Hz or less.

Caution: When disabling OL2 protection, (L8-19=0) verify that the motor current will not go beyond the current limit level when operating below 10 Hz. Or set the carrier frequency equal to or less than 2 kHz.

O Operator Parameters
01 Monitor Selection

01-01 Monitor Selection

User Monitor Sel

B	B	B	B
---	---	---	---

The top level in the operation menu allows the viewing of four monitor variables. These are F_{ref} , F_{out} , I_{out} , and a user-selected monitor. This function can replace the output voltage monitor with another monitor in the operation mode. Choose one of the monitors *UI-04* to *UI-39* in this parameter.

Setting	Description
4	Control method
5	Motor speed
6	Output voltage (factory default)
7	DC bus voltage
8	Output power
9	Torque reference (internal)
10	Input terminal status
11	Output terminal status
12	Internal control status 1
13	Elapsed time
14	FLASH ID number
15	Terminal 13 input voltage level
16	Terminal 14 input voltage or current level
17	Terminal 16 input voltage level
18	Motor secondary current (Iq)
19	Motor excitation current (Id)
20	SFS output frequency
21	ASR input
22	ASR output
23	Speed deviation
24	PID feedback
25	DI-16H reference
26	Voltage reference (Vq output)
27	Voltage reference (Vd output)
28	CPU ID number
32	ACR (q) Output
33	ACR (d) Output
34	OPE Detected
35	Zero Servo Pulse
36	PID Deviation
37	PID Output Monitor
38	PID Setpoint

01-02 Monitor Selection After Power-up

Power-On Monitor

B	B	B	B
---	---	---	---

Selects the monitor to be displayed on the digital operator immediately after the power supply is turned ON.

Setting	Description
1	Displays frequency reference (<i>factory default</i>).
2	Displays output frequency.
3	Displays output current.
4	Displays the monitor set in 01-01.

01-03 Scale for Setting and Monitoring Frequency

Display Scaling

B	B	B	B
---	---	---	---

Units for parameters and monitors related to frequency can be scaled as shown below.

Setting	Description
00000	Unit: 0.01Hz (<i>factory default</i>)
00001	Unit: 0.01%
00002 to 00039	Unit: rpm (0 to 3999)
00040 to 03999 (user-selected units)	Digits: <u>5th</u> <u>4th</u> <u>3rd</u> <u>2nd</u> <u>1st</u> 0 0 0 0 0 The 1st thru 4th digits determine the set value at 100% output frequency. Decimal point position is set by the 5th digit as follows: 5th digit = 0: displayed as 0000 5th digit = 1: displayed as 000.0 5th digit = 2: displayed as 00.00 5th digit = 3: displayed as 0.000 <i>Example 1</i> If 100% output frequency is equal to 200.0 units: Set 01-03 = "12000"; 100% of this reference is displayed as 200.0 and 60% of this reference is displayed as 120.0. <i>Example 2</i> If 100% output frequency is equal to 65.00: Set 01-03 = "26500"; 60% of this reference is displayed as 39.00.

01-04 Display Units for Speed-Related Parameters *Display Units*

-	-	-	B
---	---	---	---

Sets the display units for parameters and monitors related to frequency, in the flux vector control mode.

Setting	Description
0	Displays frequency in Hz (<i>factory default</i>).
1	Displays frequency in rpm.

01-05 Parameter Selection *Address Display*

A	A	A	A
---	---	---	---

Selects how the parameter addresses are displayed on the digital operator.

Setting	Description
0	Displays parameter number (<i>factory default</i>).
1	Displays MODBUS address.

02 Key Selections

02-01 Local/Remote Key *Local/Remote Key*

B	B	B	B
---	---	---	---

Enables/disables the digital operator LOCAL/REMOTE key.

Setting	Description
0	Local/Remote key is disabled.
1	Local/Remote key is enabled (<i>factory default</i>). Depressing the Local/Remote key switches operation commands between the digital operator and the settings of <i>B1-01</i> and <i>B1-02</i> .

02-02 STOP Key During External Terminal Operation *Oper STOP Key*

B	B	B	B
---	---	---	---

Enables/disables the digital operator STOP key, during operation from the external terminals and during serial communication.

Setting	Description
0	The digital operator STOP key is disabled when Run command does <i>not</i> come from the digital operator.
1	The digital operator STOP key is always enabled (<i>factory default</i>). The STOP key is enabled even during external terminal operation and serial communication.

O2-03 User-Defined Default Value Setting

User Defaults

B	B	B	B
---	---	---	---

Parameters set by user can be stored in the inverter as user default values.

Setting	Description
0	No change (<i>factory default</i>)
1	Sets user-specified values as defaults. Each parameter's set values are stored as user defaults. Even if the values are changed after this parameter is set, user defaults can be restored by setting A1-03 = "1110" (user initialization). Up to 50 changed values can be stored.
2	Clears user defaults.

O2-04 Inverter Model Selection

Inverter Model #

A	A	A	A
---	---	---	---

Setting Range: 23P7 to 2075, 43P7 to 4300

Factory Default: Inverter model dependent

Sets the inverter capacity, according to model number. Control parameters with defaults specific to the inverter capacity are set automatically (i.e. carrier frequency, motor data, etc.). This parameter does *not* need changing, unless the control board is replaced.

O2-05 Digital Operator M.O.P. Mode Selection

Operator M.O.P.

A	A	A	A
---	---	---	---

Selects whether the ENTER key is used when the frequency reference is set by the digital operator. The digital operator can simulate a motor operated potentiometer (M.O.P.) by setting this parameter.

Setting	Description
0	The digital operator M.O.P. mode is disabled (<i>factory default</i>). The inverter accepts the frequency reference command when the ENTER key is depressed.
1	The digital operator M.O.P. mode is enabled. The inverter accepts the frequency reference command as soon as changes are made with the arrow keys, <i>without</i> the ENTER key being depressed.

02-06 Digital Operator Disconnection Detection *Oper Detection*

A	A	A	A
---	---	---	---

If the digital operator is disconnected from the inverter, this parameter selects whether the inverter detects this condition.

Setting	Description
0	Detection is disabled. Operation continues (<i>factory default</i>).
1	Detection is enabled. When the inverter detects that the digital operator has been disconnected while running, the inverter coasts to stop and the error message "OPR Operator Disconnected" is displayed on the digital operator, after it is connected again.

This function can only be activated when the run command comes from the digital operator.

02-07 Operation Time Setting *Elapsed Time Set*

A	A	A	A
---	---	---	---

Setting Range: 0 to 65535 Hours
 Factory Default: 0 Hours

Sets the initial value for the cumulative operation time. Operation time starts accumulating from the set value. This is very useful for preventive maintenance purposes.

02-08 Cumulative Operation Time Selection *Elapsed Time Run*

A	A	A	A
---	---	---	---

Defines the operation time that accumulates in the timer.

Setting	Description
0	Power-On time is the accumulated time (<i>factory default</i>). The timer counts the time while the inverter power supply is turned ON as operation time.
1	Running time is the accumulated time. The timer counts the time while the inverter is running as operation time.

02-09 Initialization Mode Selection *Init Mode Sel*

A	A	A	A
---	---	---	---

Sets factory defaults to worldwide specifications.

Setting	Description
0	Japanese specifications
1	American specifications (<i>factory default</i>)
2	European specifications
3	OMRON specifications

After changing this setting, reinitialize the inverter in parameter A1-03. This initialization affects market-driven parameter settings (motor-related parameters, carrier frequency, inverter rated current, etc.)

Main Menu: Auto-Tuning <ENTER>

Adaptation to most all 3 phase induction motors manufactured worldwide is possible with the VS-616G5's automatic tuning function. Available in both open loop vector and flux vector control modes, the inverter asks the user for minimal motor information, then guides the user through a quick, simple tuning process. Below is the motor data required for automatic tuning in the quick-start mode:

<i>Motor Rated Voltage</i>	Sets motor rated voltage in VAC.	–	–	0	0
<i>Motor Rated Current</i>	Sets motor rated current in A.	–	–	0	0
<i>Motor Rated Frequency</i>	Sets motor rated frequency in Hz.	–	–	0	0
<i>Motor Rated Speed</i>	Sets motor rated speed in rpm.	–	–	0	0
<i>Number of Motor Poles</i>	Sets the number of motor poles.	–	–	0	0
<i>Motor Selection</i>	Chooses connected motor as 1st or 2nd motor.	–	–	0	0

After scrolling through tuning parameters using the ^ key, depress the Run key to begin auto-tuning. During tuning, “Tune Proceeding” flashes on the digital operator display. After complete, “Tune Successful” is displayed.

Note: If the Stop key is depressed during tuning, auto-tuning is interrupted and the motor coasts to stop. The data changed during tuning returns to its original values.

After tuning is complete, depress the Menu key to exit the auto-tuning mode.

1. Parameter List

Function	Parameter No.	Name (Digital Operator Display)	Setting Range	Setting Unit	Factory Setting	Remarks (Digital Operator Display)	Change during Operation o: Enabled x: Disabled	Parameter Access Level				User Setting	
								V/f	V/f w/ PG	Open Loop Vector	Flux Vector		
Initialize	Initialization	A1-00	Language Selection (Select Language)	0-1	1	1 (Note1)	0: English 1: Japanese 2: Deutsch <1110> 3: Francais <1110> 4: Italiano <1110> 5: Espanol <1110> 6: Portugues <1110>	o	Q	Q	Q	Q	
		A1-01	Access Level (Access Level)	0-4	1	2	0: Operation Only 1: User Level (Note 5) 2: Quick-Start [Q] 3: Basic Level [B] 4: Advanced Level [A]	o	Q	Q	Q	Q	
		A1-02	Control Method Selection (Control method)	0-3	1	0 (Note1)	0: V/F Control 1: V/F w/PG Fdbk 2: Open Loop Vector 3: Flux Vector	x	Q	Q	Q	Q	
		A1-03	Initialize (Init Parameters)	0 1110 2220 3330	N/A	0	0 : No Initialize 1110: User Initialize (Note 7) 2220: 2-Wire Initialize 3330: 3-Wire Initialize	x	Q	Q	Q	Q	
		A1-04	Password 1 * (Enter Password)	0000~ 9999	1	0000	Password protection for: A1-01 Access Level A1-02 Control Method A1-03 Initialization A2-01 to A2-32 User Parameters (If selected)	x	Q	Q	Q	Q	
User Parameters	A2-01 ~ A2-32	User Setting Parameters (Function A2)	—	—	—	User Parameter 1 to User Parameter 32	x	A	A	A	A		
Note 1		Not initialized. (Domestic standard specifications: A1-01 = 1, A1-02 = 2)											
Note 2		Setting range is only 0 and 1 when the control method is set to flux vector control (A1-02 = 3)											
Note 5		Selection "1: User Level" is only available after selecting setting 4: Advanced Level and then entering a user parameter in A2-01.											
Note 7		Setting 1110: User Initialize is only available after setting Parameter No. 02-03 to 1.											

Function	Parameter No.	Name (Digital Operator Display)	Setting Range	Setting Unit	Factory Setting	Remarks (Digital Operator Display)	Change during Operation o: Enabled x: Disabled	Parameter Access Level				User Setting
								V/f	V/f w/ PG	Open Loop Vector	Flux Vector	
Group B Application Function b1 Sequence	B1-01	Reference Selection (Reference Source)	0 ~ 4	1	1	0: (Operator) 1: (Terminals) 2: Communication (Serial Com) 3: (Option PCB) 4: (EWS) Reference from CP-717 <1110>(Note 8)	x	Q	Q	Q	Q	
	B1-02	Operation Method Selection (Run Source)	0 ~ 4	1	1	0: (Operator) 1: (Terminals) 2: Communication(Serial Com) 3: (Option PCB) 4: (EWS) Run from CP-717 <1110> (Note 8)	x	Q	Q	Q	Q	
	B1-03	Stopping Method Selection (Stopping Method)	0 ~ 3 (Note 2)	1	0	0: (Ramp to Stop) 1: (Coast to Stop) 2: DC injection to stop (DCInj to Stop) 3: Coast to stop with timer (Coast w/Timer)	x	Q	Q	Q	Q	
	B1-04	Reverse Operation Prohibit (Reverse Oper)	0, 1	1	0	0: (Reverse Enabled) 1: (Reverse Disabled)	x	B	B	B	B	
	B1-05	Operation Selection for Setting of E1-09 or less (Zero-Speed Oper)	0 ~ 3	1	0	0: Run at frequency reference (Run at Freq Ref) 1: (STOP) 2: Run at minimum frequency (RUN at Min Freq) 3: (RUN at Zero RPM)	x	-	-	-	A	
	B1-06	Digital Input Scan Time (Cntl Input Scans)	0, 1	1	1	0: (2 mS - 2 Scans) 1: (5 mS - 2 Scans)	x	A	A	A	A	
	B1-07	Operation selection after switching to remote mode (LOC/REM RUN Sel)	0, 1	1	0	0: Cycle external run (Cycle Extern RUN) 1: Accept external run (Accept Extern RUN)	x	A	A	A	A	
	B1-08 <1110>	Run command acceptance while being programmed (RUN CMD at PRG)	0, 1	1	0	0: Disabled 1: Enabled	x	A	A	A	A	

Note 2 Setting range is only 0 and 1 when the control method is set to flux vector control (A1-02 = 3)

Note 8 (Tentative) Setting parameter B1-01 or B1-02 to 4 allows reference and/or run source from CP-717 when either CP-916 or CP-216 option cards are installed.

Note 9 Drive can be switched between local and remote mode while continuing to run. When switching from remote to local the last remote speed command will be set as the local speed for a bumpless transition.

Appendix
VS-616G5 Parameter List B Application

Function	Parameter No.	Name (Digital Operator Display)	Setting Range	Setting Unit	Factory Setting	Remarks (Digital Operator Display)	Change during Operation o: Enabled x: Disabled	Parameter Access Level				User Setting	
								V/f	V/f w/ PG	Open Loop Vector	Flux Vector		
Group b Application	Function b2 DC Injection Brake	B2-01	DC Injection Braking Starting Frequency (DCInj Start Freq)	0.0~10.0	0.1Hz	0.5	—	x	B	B	B	B	
		B2-02	DC Injection Current (DCInj Current)	0~100	1%	50	—	x	B	B	B	-	
		B2-03	DC Injection Time at Start (DCInj Time @Start)	0.00~10.00	0.01s	0.00	—	x	B	B	B	B	
		B2-04	DC Injection Braking Time at Stop (DCInj Time @Stop)	0.00~10.00	0.01s	0.50 *	* When 02-09 = 1 (American), the setting is 0.00s. <24>	x	B	B	B	B	
		B2-08 <1110>	Magnetic Flux Compensation Capacity (FieldComp)	0~500	1%	0	100% is no-load current value at Min. frequency (E1-09)	x	-	-	A	A	
	Speed Search	B3-01	Speed Search Selection at Start (SpdSrch at Start)	0,1	1	0*	0: Disabled 1: Enabled * Factory setting defaults to 0: Disabled except when (A1-02=1) (V/F w/PG Fdbk) or 3 (Flux Vector).	x	A	A	A	A	
		B3-02	Speed Search Operation Current (SpdSrch Current)	0~200	1%	150*	* Factory setting defaults to 150 when A1-02=0 (V/F Control). When A1-02=2 (Open Loop Vector), the default is 100.	x	A	-	A	-	
		B3-03	Speed Search Deceleration Time (SpdSrch Dec Time)	0.1~10.0	0.1s	2.0	—	x	A	-	A	-	
	Delay Timers Brake Sequence	B4-01	Timer Function On-delay Time (Delay-ON Timer)	0.0~300.0	0.1s	0.0	—	x	A	A	A	A	
		B4-02	Timer Function Off-delay Time (Delay-OFF Timer)	0.0~300.0	0.1s	0.0	—	x	A	A	A	A	

Function	Parameter No.	Name (Digital Operator Display)	Setting Range	Setting Unit	Factory Setting	Remarks (Digital Operator Display)	Change during Operation o: Enabled x: Disabled	Parameter Access Level				User Setting
								V/f	V/f w/ PG	Open Loop Vector	Flux Vector	
Group b Application Function b5 PID Control	B5-01	PID Control Mode Selection (PID Mode)	0 ~ 4	1	0	0: (Disabled) 1: (Enabled D=Fdbk) 2: Enabled D = Feed-Forward (Enabled D=Fdfwd) 3: Reference = Frequency Reference + PID Output (Fref+PID D=Fdbk) 4: Reference = Frequency Reference + PID Output D is feed-forward (Fref+PID D=Fdfwd)	x	A	A	A	A	
	B5-02	Proportional Gain (P) (PID Gain)	0.00~25.00	0.01	1.00	—	o	A	A	A	A	
	B5-03	Integral (I) Time (PID I Time)	0.0~360.0	0.1s	1.0	—	o	A	A	A	A	
	B5-04	Integral (I) Limit (PID I Limit)	0.0~100.0	0.1%	100	—	o	A	A	A	A	
	B5-05	Derivative (D) Time (PID D Time)	0.00~10.00	0.01s	0.00	—	o	A	A	A	A	
	B5-06	PID Limit (PID Limit)	0.00~100.0	0.1%	100.0	—	o	A	A	A	A	
	B5-07	PID Offset Adjustment (PID Offset)	-100.0~+100.0	0.1%	0.0	—	o	A	A	A	A	
	B5-08	PID Primary Delay Time (PID Delay Time)	0.00~10.00	0.01s	0.00	—	o	A	A	A	A	
	B5-09 <1110>	PID Output Selection (Output Level Sel)	0, 1	1	0	0: PID Forward Output [X 1] (Normal Character) 1: PID Reverse Output [X-1] (Rev Character)	x	A	A	A	A	
	B5-10 <1110>	PID Output Gain (Output Gain)	0.0 ~ 25.0	.1	1.0	—	x	A	A	A	A	
	B5-11 <1110>	PID Output Reverse Selection (Output Rev Sel)	0, 1	1	0	0: When PID output is negative, motor direction is not changed, PID output is limited to 0. (0 limit) 1: When PID output is negative, motor reverses direction. (Reverse)	x	A	A	A	A	

Function	Parameter No.	Name (Digital Operator Display)	Setting Range	Setting Unit	Factory Setting	Remarks (Digital Operator Display)	Change during Operation o: Enabled x: Disabled	Parameter Access Level				User Setting		
								V/f	V/f w/ PG	Open Loop Vector	Flux Vector			
Group b Application	PID Control	B5-12 <1110>	PID Feedback Reference Missing Detection Selection (Fb Los Det Sel)	0~2	1	0	0: PID feedback missing detection disabled. (Disabled) 1: PID feedback missing detection enabled. (Alarm) Operation continues after detection, "Fbl" alarm is displayed. 2: PID feedback missing detection enabled. (Fault) Inverter output is shut off after detection, "Fbl" is displayed.	x	A	A	A	A		
		B5-13 <1110>	PID Feedback Reference Missing Detection Level (Fb los Det Lvl)	0~100	1%	0	—	x	A	A	A	A		
		B5-14 <1110>	PID Feedback Reference Missing Detection Time (Fb los Det Time)	0.0~25.5	0.1s	1.0	—	x	A	A	A	A		
	Function b6 Reference Hold	B6-01	Dwell Frequency at Start (Dwell Ref @Start)	0.0~400.0	0.1Hz	0.0	—	x	A	A	A	A		
		B6-02	Dwell Time at Start (Dwell Time @ Start)	0.0~10.0	0.1s	0.0	—	x	A	A	A	A		
		B6-03	Dwell Frequency at Stop (Dwell Ref @ Stop)	0.0~400.0	0.1Hz	0.0	—	x	A	A	A	A		
		B6-04	Dwell Time at Stop (Dwell Time @ Stop)	0.0~10.0	0.1s	0.0	—	x	A	A	A	A		
	Function b7 Droop Control	Droop Control	B7-01	Droop Control Gain (Droop Quantity)	0.0~100.0	0.1%	0.0	—	o	-	-	-	A	
			B7-02	Droop Control Delay Time (Droop Delay Time)	0.03~2.00	0.01s	0.05	—	o	-	-	-	A	

Function	Parameter No.	Name (Digital Operator Display)	Setting Range	Setting Unit	Factory Setting	Remarks (Digital Operator Display)	Change during Operation o: Enabled x: Disabled	Parameter Access Level				User Setting	
								V/f	V/f w/ PG	Open Loop Vector	Flux Vector		
Group b Application	Function b8 Energy Saving	B8-01	Energy-saving Gain (Energy Save Gain)	0~100	1%	80	—	x	A	A	-	-	
		B8-02	Energy-saving Frequency (Energy Save Freq)	0.0~400.0	0.1Hz	0.0	—	x	A	A	-	-	
		B8-03 <1110>	Energy -saving Mode Selection	0, 1	1	0	0: (Disabled) 1: (Enabled)	x	-	-	F (A) Note	F (A) Note	
		B8-04 <1110>	Energy-saving Control Gain (Energy Save Gain)	0.0~10.0	0.1	0.7*	*When control mode A1-02 = 3, default factory setting becomes 1.0	o	-	-	F (A) Note	F (A) Note	
		B8-05 <1110>	Energy-saving Control Time Constant (Energy Save F .T)	0.00~10.00	0.01s	0.50*	*When control mode A1-02 = 3, default factory setting becomes 0.1	o	-	-	F (A) Note	F (A) Note	
	Zero Servo	B9-01	Zero-servo gain (Zero Servo Gain)	0~100	1	5	—	x	-	-	-	A	
		B9-02	Zero-servo Completion Width (Zero Servo Count)	0~16383	1	10	—	x	-	-	-	A	
							Note: USA (02x09=1) and EUR. (02x09=2) are Advanced, others are Factory setting.						
Group C Tuning	Function C1 Accel / Decel	C1-01	Acceleration Time 1 (Accel Time 1)	Depends on C1-10 0.00~600.00 or 0.0 ~ 6000.0	Depends on C1-10 0.01s or 0.1s	10.0	—	o	Q	Q	Q	Q	
		C1-02	Deceleration Time 1 (Decel Time 1)			10.0	—	o	Q	Q	Q	Q	
		C1-03	Acceleration Time 2 (Accel Time 2)			10.0	—	o	B	B	B	B	
		C1-04	Deceleration Time 2 (Decel Time 2)			10.0	—	o	B	B	B	B	
		C1-05	Acceleration Time 3 (Accel Time 3)			10.0	—	x	A	A	A	A	
		C1-06	Deceleration Time 3 (Decel Time 3)			10.0	—	x	A	A	A	A	
		C1-07	Acceleration Time 4 (Accel Time 4)			10.0	—	x	A	A	A	A	
		C1-08	Deceleration Time 4 (Decel Time 4)			10.0	—	x	A	A	A	A	
		C1-09	Emergency Stop Time (Fast Stop Time)			10.0	—	x	B	B	B	B	
		C1-10	Accel/Decel Time Set Unit (Acc/Dec Units)			0.1	1	1	0: Set unit of accel/decel time is 0.01s. (0.01 Seconds) 1: Set unit of accel/decel time is 0.1s. (0.1 Seconds)	x	A	A	A
	C1-11	Accel/Decel Time Switching Frequency (Acc/Dec SW Freq)	0.0~400.0	0.1Hz	0.0	—	x	A	A	A	A		

Function	Parameter No.	Name (Digital Operator Display)	Setting Range	Setting Unit	Factory Setting	Remarks (Digital Operator Display)	Change during Operation o: Enabled x: Disabled	Parameter Access Level				User Setting
								V/f	V/f w/ PG	Open Loop Vector	Flux Vector	
Function C2 S-Curve Acc/Dec	C2-01	S-Curve Characteristic Time at Acceleration Start (SCrv Acc@ Start)	0.00~2.50	0.01s	0.20	—	x	A	A	A	A	
	C2-02	S-Curve Characteristic Time at Acceleration End (SCrv Acc@ End)	0.00~2.50	0.01s	0.20	—	x	A	A	A	A	
	C2-03	S-Curve Characteristic Time at Deceleration Start (SCrv Dec @ Start)	0.00~2.50	0.01s	0.20	—	x	A	A	A	A	
Group C Tuning Function C3 Motor Slip Compensation	C3-01	Slip Compensation Gain (Slip Comp Gain)	0.0~2.5	0.1	1.0*	* Default factory setting is 0.0 when A1-02=0 [V/F mode]. When A1-02=2 [Open Loop Vector] or 3 [Flux Vector] default factory setting is 1.0	o	B	-	B	B	
	C3-02	Slip Compensation Primary Delay Time (Slip Comp Time)	0~10000	1 ms	200*	* Default factory setting is 2000ms when A1-02=0 [V/F mode]. When A1-02=2 [Open Loop Vector] default factory setting is 200ms.	x	A	-	A	-	
	C3-03	Slip Compensation Limit (Slip Comp Limit)	0~250	1%	200	—	x	A	-	A	-	
	C3-04	Slip Compensation Selection during Regeneration (Slip Comp Regen)	0, 1	1	0	0 : Disabled 1 : Enabled	x	A	-	A	-	
	C3-05 <1110>	Flux Calculation Method (Flux Select)	0, 1	1	0	0 : Magnetic flux is calculated by output frequency after compensation. (Slip Included) 1 : Magnetic flux is calculated by output frequency before compensation. (Slip Excluded)	x	-	-	A	-	
	C3-06 <1110>	Output Voltage Limit Operation Selection (Output V limit)	0, 1	1	0	0 : Disabled (Note 10) 1 : Enabled (Note 11)	x	-	-	A	A	
Note 10	When this parameter is "0" slip compensation will be disabled when the motor is operating above its base speed. The motor voltage will not be reduced above base speed.											
Note 11	Open Loop Vector: When this parameter is set to "1" the motor voltage will be reduced slightly when the motor is operating above 90% base speed. Slip Compensation is enabled. Speed control accuracy is improved. This may prevent speed instabilities due to motor voltage saturation. This setting may improve speed regulation however motor torque/amp will be reduced by up to 10% due to motor voltage reduction above base speed. Flux Vector: Torque linearity is improved.											

Function	Parameter No.	Name (Digital Operator Display)	Setting Range	Setting Unit	Factory Setting	Remarks (Digital Operator Display)	Change during Operation o: Enabled x: Disabled	Parameter Access Level				User Setting
								V/f	V/f w/ PG	Open Loop Vector	Flux Vector	
Group C Tuning	Function C4 Torque Compensation											
	C4-01	Torque Compensation Gain (Torq Comp Gain)	0.00~2.50	0.01	1.00	—	o	B	B	B	-	
	C4-02	Torque Compensation Time (Torq Comp Time)	0~10000	1 ms	20*	* When A1-02=2 [Open Loop Vector] factory default setting is 20 ms. When A1-02=1or 3 [V/F or V/F w/PG] factory default setting is 200 ms.	x	A	A	A	-	
	C4-03 <1110>	Forward Torque Compensation Value @ Start (F TorqCmp @start)	0.0~200.0	0.1%	0.0	Functions only when starting a motor. Torque reference and motor flux can be ramped up quickly to improve speed response during start. A setting of 0.0 disables this feature.	x	-	-	A	-	
	C4-04 <1110>	Reverse Torque Compensation Value @ Start. (R TorqCmp @ start)	200.0~0.0	0.1%	0.0	Functions only when starting a motor. Torque reference and motor flux can be ramped up quickly to improve speed response during start. A setting of 0.0 disables this feature.	x	-	-	A	-	
	C4-05 <1110>	Torque Compensation Time Constant (TorqCmp Delay T)	0~200	1ms	10	When 0~4ms is set, it is operated without filter. Functions with C4-03 and C4-04.	x	-	-	A	-	
	Function C5 ASR Tuning											
	C5-01	ASR Proportional (P) Gain 1 (ASR P Gain 1)	0.00~300.00	0.01	20.00*	When A1-02=1 [V/f w/PG] factory default setting is .20. When A1-02=3 factory default setting is 20.00.	o	-	B	-	B	
	C5-02	ASR Integral (I) Time 1 (ASR 1 Time 1)	0.000~10.000	0.001s	0.500*	When A1-02=1 [V/f w/PG] factory default setting is .200. When A1-02=3 factory default setting is .500	o	-	B	-	B	
	C5-03	ASR Proportional (P) Gain 2 (ASR P Gain 2)	0.00~300.00	0.01	20.00*	When A1-02=1 [V/f w/PG] factory default setting is .02 When A1-02=3 factory default setting is 20.00.	o	-	B	-	B	
	C5-04	ASR Integral (I) Time 2 (ASR 1 Time 2)	0.000~10.000	0.001s	0.500*	When A1-02=1 [V/f w/PG] factory default setting is .050. When A1-02=3 factory default setting is .500.	o	-	B	-	B	
	C5-05	ASR Limit (ASR Limit)	0.0~20.0	0.1%	5.0	—	x	-	A	-	-	
	C5-06	ASR Primary Delay Time (ASR Delay Time)	0.000~0.500	0.001s	0.004	—	x	-	-	-	A	
C5-07	ASR Switching Frequency (ASR Gain SW Freq)	0.0~400.0	0.1Hz	0.0	—	x	-	-	-	A		
C5-08	ASR Integral Limit (ASR I Limit)	0~400	1	400%	—	x	-	-	-	A		

Appendix
VS-616G5 Parameter List C Tuning

Function	Parameter No.	Name (Digital Operator Display)	Setting Range	Setting Unit	Factory Setting	Remarks (Digital Operator Display)	Change during Operation o: Enabled x: Disabled	Parameter Access Level				User Setting	
								V/f	V/f w/ PG	Open Loop Vector	Flux Vector		
Group C Tuning	Function C6 Carrier Frequency	C6-01	Carrier Frequency Upper Limit (Carrier Freq Max)	0.4-15.0**	0.1 kHz	15.0**	When control mode is vector control (A1-02=2, 3), the setting range of C6-01 and C6-02 is 2.0 ~15.0. ** Setting range and factory setting differ depending on inverter capacity.	x	B	B	B	B	
		C6-02	Carrier Frequency Lower Limit (Carrier Freq Min)	0.4-15.0	0.1 kHz	15.0**		x	A	A	-	-	
		C6-03	Carrier Frequency Proportional Gain (Carrier Freq Gain)	00-99**	1	00**		x	A	A	-	-	
	Function C7 Hunting Prevention	C7-01	Hunting Prevention Selection (Hunt Prev Select)	0, 1	1	1	0: Disabled 1: Enabled	x	A	A	-	-	
		C7-02	Hunting Prevention Gain (Hunt Prev Gain)	0.00-2.50	0.01	1.00	—	x	A	A	-	-	
Group C Tuning	Function C8 Factory Tuning	C8-08	AFR Gain (AFR Gain)	0.00-10.00	0.01	1.00	—	x	-	-	A	-	
		C8-09	AFR Time Constant (AFR Time)	0-2000	1 ms	50	—	x	-	-	A	-	
	C8-30 <1110>	Carrier Frequency Selection during Auto-tuning (Carrier in tune)	0-2	1	0	0: Carrier frequency is 2 kHz. 1: Carrier frequency depends on C6-01. 2: Carrier frequency is 5 kHz. (185-300 kW: 2.5 kHz)	x	-	-	A	A		

Function	Parameter No.	Name (Digital Operator Display)	Setting Range	Setting Unit	Factory Setting	Remarks (Digital Operator Display)	Change during Operation o: Enabled x: Disabled	Parameter Access Level				User Setting	
								V/f	V/f w/ PG	Open Loop Vector	Flux Vector		
Group d Reference	Function d1 Preset Reference	D1-01	Frequency Reference 1 (Reference 1)	0.00~400.00	0.01Hz	0.00	—	o	Q	Q	Q	Q	
		D1-02	Frequency Reference 2 (Reference 2)	0.00~400.00	0.01Hz	0.00	—	o	Q	Q	Q	Q	
		D1-03	Frequency Reference 3 (Reference 3)	0.00~400.00	0.01Hz	0.00	—	o	Q	Q	Q	Q	
		D1-04	Frequency Reference 4 (Reference 4)	0.00~400.00	0.01Hz	0.00	—	o	Q	Q	Q	Q	
		D1-05	Frequency Reference 5 (Reference 5)	0.00~400.00	0.01Hz	0.00	—	o	B	B	B	B	
		D1-06	Frequency Reference 6 (Reference 6)	0.00~400.00	0.01Hz	0.00	—	o	B	B	B	B	
		D1-07	Frequency Reference 7 (Reference 7)	0.00~400.00	0.01Hz	0.00	—	o	B	B	B	B	
		D1-08	Frequency Reference 8 (Reference 8)	0.00~400.00	0.01Hz	0.00	—	o	B	B	B	B	
		D1-09	Jog Frequency Reference (Jog Reference)	0.00~400.00	0.01Hz	6.00	—	o	Q	Q	Q	Q	
	Function d2 Reference Limits	D2-01	Frequency Reference Upper Limit (Ref Upper Limit)	0.0~110.0	0.1%	100.0	—	x	B	B	B	B	
		D2-02	Frequency Reference Lower Limit (Ref Lower Limit)	0.0~109.0	0.1%	0.0	—	x	B	B	B	B	
	Function d3 Jump Frequencies	D3-01	Jump Frequency 1 (Jump Freq 1)	0.0~400.0	0.1Hz	0.0	—	x	B	B	B	B	
		D3-02	Jump Frequency 2 (Jump Freq 2)	0.0~400.0	0.1Hz	0.0	—	x	B	B	B	B	
D3-03		Jump Frequency 3 (Jump Freq 3)	0.0~400.0	0.1Hz	0.0	—	x	B	B	B	B		
D3-04		Jump Frequency Width (Jump Bandwidth)	0.0~20.0	0.1Hz	1.0	—	x	B	B	B	B		

Function	Parameter No.	Name (Digital Operator Display)	Setting Range	Setting Unit	Factory Setting	Remarks (Digital Operator Display)	Change during Operation o: Enabled x: Disabled	Parameter Access Level				User Setting	
								V/f	V/f w/ PG	Open Loop Vector	Flux Vector		
Group d Reference	Function d4 Sequence	D4-01	Frequency Reference Hold Function Selection (MOP Ref Memory)	0, 1	1	0	0: (Disabled) No hold frequency is memorized. 1: (Enabled) Hold frequency is memorized.	x	A	A	A	A	
		D4-02	±Speed Limits (Trim Control Lvl)	0~100	1%	25*	*When 02-09=1 [USA], the unit is 10%. <24>	x	A	A	A	A	
	Function d5 Torque Control	D5-01	Torque Control Selection (Torq Control Sel)	0, 1	1	0	0: (Speed Control) 1: (Torque Control)	x	-	-	-	A	
		D5-02	Torque Reference Delay Time (Torque Ref Filter)	0~1000	1 ms	0	—	x	-	-	-	A	
		D5-03	Speed Limit Selection (Speed Limit Sel)	1, 2	1	1	1: (Analog Input) terminal 13, 14 2: (Program Setting)	x	-	-	-	A	
		D5-04	Speed Limit (Speed Lmt Value)	-120 ~ +120	1%	0	—	x	-	-	-	A	
		D5-05	Speed Limit Bias (Speed Lmt Bias)	0~120	1%	10	—	x	-	-	-	A	
		D5-06	Speed/torque Control Switching Timer (Ref Hold Time)	0~1000	1 ms	0	—	x	-	-	-	A	

Function	Parameter No.	Name (Digital Operator Display)	Setting Range	Setting Unit	Factory Setting	Remarks (Digital Operator Display)	Change during Operation o: Enabled x: Disabled	Parameter Access Level				User Setting
								V/f	V/f w/ PG	Open Loop Vector	Flux Vector	
Group E Motor Function E1 V/F Pattern	E1-01	Input Voltage Setting (Input Voltage)	155~255 (Note 13)	1 V	200 (Note 13)	*When 02-09=1 [USA], the value is 1.15 times of Japanese spec., which is 230/200	x	Q	Q	Q	Q	
	E1-02	Motor Selection (Motor Selection)	0, 1, 2	1	0	0: (Std Fan-Cooled) 1: (Std Blower-Cooled) 2: (Vector Motor) <1110>	x	Q	Q	Q	Q	
	E1-03	V/f Pattern Selection (V/F Selection)	00~0F	1	0F	V/f pattern selection 0: 50Hz 1: 60Hz Saturation 2: 50Hz Saturation 3: 72Hz 4: 50Hz Variable Torque 1 5: 50Hz Variable Torque 1 6: 60Hz Variable Torque 1 7: 60Hz Variable Torque 2 8: 50Hz High Starting Torque 1 9: 50Hz High Starting Torque 2 A: 60Hz High Starting Torque 1 B: 60Hz High Starting Torque 2 C: 90Hz D: 120Hz E: 180Hz F: User-defined V/f pattern	x	Q	Q	Q	Q	
	E1-04	Max. Output Frequency (Max Frequency)	40.0~40 0.0	0.1Hz	60.0* (Note 13)	*Factory setting differs depending on the inverter capacity 02-04. When 02-09=2 [EUR.], the value is 50.0Hz.	x	Q	Q	Q	Q	
	E1-05	Max. Voltage (Max Voltage)	0.0~255.0 (Note 13)	0.1 V	200.0 (Note 13)*	*Factory setting differs depending on the inverter capacity (02-04). When 02-09=1 (USA), the value is 1.15 times of Japanese spec., which is 230/200	x	Q	Q	Q	Q	
Note 13: This value is for the 200V class. For 400V class, the value is twice that of 200V class. For 575V class, then modify the values by 575/200												

Appendix
VS-616G5 Parameter List E Motor

Function	Parameter No.	Name (Digital Operator Display)	Setting Range	Setting Unit	Factory Setting	Remarks (Digital Operator Display)	Change during Operation o: Enabled x: Disabled	Parameter Access Level				User Setting
								V/f	V/f w/ PG	Open Loop Vector	Flux Vector	
Group E Motor Torque Control	E1-06	Max. Voltage Frequency (Base Frequency)	0.0~400.0	0.1Hz	60.0* (Note 13)	*Factory setting differs depending on the inverter capacity (02-04). When 02-09=2 (EUR.), the value is 50.0Hz.	x	Q	Q	Q	Q	
	E1-07	Mid. Output Frequency (Mid Frequency A)	0.0~400.0	0.1Hz	3.0* (Note 13)	*Factory setting differs depending on the inverter capacity (02-04). When 02-09=2 (EUR.), A1-02=0, and E1-03=OF, the value is 5/6 times that of Japan spec.[for a V/F pattern with a 50Hz base frequency]	x	Q	Q	A	F	
	E1-08	Mid. Output Frequency Voltage (Mid Voltage A)	0.00~255.0 (Note 13)	0.1 V	11.0 (Note 13)*	*Factory setting differs depending on the inverter capacity (02-04). When 02-09=1 (USA), the value is 1.15 times of Japanese spec., which is 230/200 .	x	Q	Q	A	F	
	E1-09	Min. Output Frequency (Min Frequency)	0.0~400.0	0.1Hz	0.5* (Note 13)	*Factory setting differs depending on the inverter capacity (02-04). When 02-09=2 (EUR.), A1-02=0, and E1-03=OF, the value is 5~6 times of Japan.	x	Q	Q	Q	A	
	E1-10	Min. Output Frequency Voltage (Min Voltage)	0.0~255.0 (Note 13)	0.1V	2.0 (Note 13)*	*Factory setting differs depending on the inverter capacity (02-04). When 02-09=1 (USA), the value is 1.15 times of Japanese spec., which is 230/200.	x	Q	Q	A	F	
	E1-11	Mid. Output Frequency 2 (Mid Frequency B)	0.0~400.0	0.1Hz	0.0	—	x	A	A	A	A	
	E1-12	Mid. Output Frequency Voltage 2 (Mid Voltage B)	0.0~255.0 (Note 13) *	0.1V	0.0	*When 02-09=1 (USA), the value is 1.15 times of Japanese spec., which is 230/200.	x	A	A	A	A	
	E1-13	Base Voltage (Base Voltage)	0.0~255.0 (Note 13)	0.1V	200.0 (Note 13) *	*When 02-09=1 (USA), the value is 1.15 times of Japanese spec., which is 230/200.	x	A	A	Q	Q	
Note 13: This value is for the 200V class. For 400V class, the value is twice that of 200V class. For 575V class, then modify the values by 575/200												

Function	Parameter No.	Name (Digital Operator Display)	Setting Range	Setting Unit	Factory Setting	Remarks (Digital Operator Display)	Change during Operation o: Enabled x: Disabled	Parameter Access Level				User Setting
								V/f	V/f w/ PG	Open Loop Vector	Flux Vector	
Group E Motor Function E2 Motor Setup	E2-00	Motor Rated (Motor Rated)	—	—	—	* When inverter capacity is 7.5 kW or less, min. setting unit becomes 0.01 A. ** Factory setting differs depending on inverter capacity (02-04).	x	-	-	-	-	
	E2-01	Motor Rated Current (Motor Rated FLA)	0.1~1500.0	0.1A*	1.9**		x	Q	Q	Q	Q	
	E2-02	Motor Rated Slip (Motor Rated Slip)	0.00~20.00	0.01Hz	2.90**		x	A	A	Q	Q	
	E2-03	Motor No-load Current (No-Load Current)	0.00~1500.0	0.01A*	1.20**		x	A	A	Q	Q	
	E2-04	Number of Motor Poles (Number of Poles)	2~48	1 pole	4		x	-	Q	-	Q	
	E2-05	Motor Line-to-line Resistance (Term Resistance)	0.000~65.000	0.001 W	9.842**		x	A	A	A	A	
	E2-06	Motor Leak Inductance (Leak Inductance)	0.0~30.0	0.1%	18.2**		x	-	-	A	A	
	E2-07	Motor Iron-core Saturation Coefficient 1 (Saturation Comp 1)	0.00~0.50	0.01	0.50	—	x	-	-	A	A	
	E2-08	Motor Iron-core Saturation Coefficient 2 (Saturation Comp 2)	0.00~0.75	0.01	0.75	—	x	-	-	A	A	
	E2-09	Motor Mechanical Loss (Mechanical Loss)	0.0~10.0	0.1%	0.0	—	x	-	-	-	A	
E2-10	Motor Iron Loss of Torque Compensation (Tcomp Iron Loss)	0~65535	1W	14	Access level is changed from F to A. <1110>	x	A	A	-	-		

Appendix
VS-616G5 Parameter List E Motor

Function	Parameter No.	Name (Digital Operator Display)	Setting Range	Setting Unit	Factory Setting	Remarks (Digital Operator Display)	Change during Operation o: Enabled x: Disabled	Parameter Access Level				User Setting
								V/f	V/f w/ PG	Open Loop Vector	Flux Vector	
Function E3 Control Method	E3-01	Motor 2 Control Method Selection (Control Method)	0~3	1	2	0: (V/F Control) 1: (V/F w/PG Fdbk) 2: (Open Loop Vector) 3: (Flux Vector)	x	A	A	A	A	
	Group E Motor Function E4 V/F Pattern 2	E4-01	Motor 2 Max. Output Frequency (Max Frequency)	40.0~400.0	0.1Hz	60.0	—	x	A (Note 14)	A (Note 14)	A (Note 14)	A (Note 14)
E4-02		Motor 2 Max. Voltage (Max Voltage)	0.0~255.0 (Note 13)	0.1V	200.0 (Note 13)	—	x	A (Note 14)	A (Note 14)	A (Note 14)	A (Note 14)	
E4-03		Motor 2 Max. Voltage Frequency (Base Frequency)	0.0~400.0	0.1Hz	60.0	—	x	A (Note 14)	A (Note 14)	A (Note 14)	A (Note 14)	
E4-04		Motor 2 Mid. Output Frequency 1 (Mid Frequency)	0.00~400.0	0.1Hz	3.0*	* Factory setting differs depending on the control method [E3-01]	x	A (Note 14)	A (Note 14)	A (Note 14)	F (Note 14)	
E4-05		Motor 2 Mid. Output Voltage 1 (Mid Voltage)	0.0~255.0 (Note 13)	0.1V	11.0 (Note 13)*	* Factory setting differs depending on the control method [E3-01]	x	A (Note 14)	A (Note 14)	A (Note 14)	F (Note 14)	
E4-06		Motor 2 Min. Output Frequency (Min Frequency)	0.0~400.0	0.1Hz	0.5*	* Factory setting differs depending on the control method [E3-01]	x	A (Note 14)	A (Note 14)	A (Note 14)	A (Note 14)	
E4-07		Motor 2 Min. Output Voltage (Min Voltage)	0.0~255.0 (Note 13)	0.1V	2.0* (Note13)	* Factory setting differs depending on the control method [E3-01]	x	A (Note 14)	A (Note 14)	A (Note 14)	F (Note 14)	
Note 13: This value is for the 200V class. For 400V class, the value is twice that of 200V class. For 575V class, then modify the values by 575/200 Note 14: Control mode is determined by E3-01.												

Function	Parameter No.	Name (Digital Operator Display)	Setting Range	Setting Unit	Factory Setting	Remarks (Digital Operator Display)	Change during Operation o: Enabled x: Disabled	Parameter Access Level				User Setting
								V/f	V/f w/ PG	Open Loop Vector	Flux Vector	
Group E Motor Function E5 Motor Setup 2	E5-01	Motor 2 Rated Current (Motor Rated FLA)	0.00~1500.0	0.1A*	1.9**	* Setting unit is 0.01A for models of 7.5 kW or less. ** Factory setting differs depending on inverter capacity (02-04).	x	A (Note 14)	A (Note 14)	A (Note 14)	A (Note 14)	
	E5-02	Motor 2 Rated Slip (Motor Rated Slip)	0.00~20.00	0.01Hz	2.90**		x	A (Note 14)	A (Note 14)	A (Note 14)	A (Note 14)	
	E5-03	Motor 2 No-load Current (No-Load Current)	0.00~1500.0	0.01A*	1.20**		x	A (Note 14)	A (Note 14)	A (Note 14)	A (Note 14)	
	E5-04	Motor 2 Number of poles (Motor 2 # Poles)	2~48	1 pole	4		x	- (Note 14)	A (Note 14)	- (Note 14)	A (Note 14)	
	E5-05	Motor 2 Line-to-line Resistor (Motor 2 term Ohms)	0.000~65.000	0.001 W	9.842**		x	A (Note 14)	A (Note 14)	A (Note 14)	A (Note 14)	
	E5-06	Motor 2 Leak Inductance (Motor 2 Leak)	0.0~30.0	0.1%	18.2**		x	A (Note 14)	- (Note 41)	A (Note 14)	A (Note 14)	
Note 13: This value is for the 200V class. For 400V class, the value is twice that of 200V class. For 575V class, modify the values by 575/200												
Note 14: Control mode is determined by E3-01.												
Group F Options * Function F1 PG Option Setup	F1-01	PG Constant (PG Pulses/Rev)	0~60000	1	600*	*When 02-09=1 (USA), 2 (EUR.), factory setting is 1024	x	-	Q	-	Q	
	F1-02	Operation Selection at PG Open Circuit (PG Fdbk Loss Sel)	0~3	1	1	0: (Ramp to Stop) 1: (Coast to Stop) 2: (Fast-Stop) 3: (Alarm Only)	x	-	B	-	B	
	F1-03	Operation Selection at Overspeed (PG Overspeed Sel)	0~3	1	1	0: (Ramp to Stop) 1: (Coast to Stop) 2: (Fast-Stop) 3: (Alarm Only)	x	-	B	-	B	
	F1-04	Operation Selection at Deviation (PG Deviation Sel)	0~3	1	3	0: (Ramp to Stop) 1: (Coast to Stop) 2: (Fast-Stop) 3: (Alarm Only)	x	-	B	-	B	
	F1-05	PG Rotation (PG Rotation Sel)	0, 1	1	0	0: Counter-clockwise (Fwd = C.C.W.) 1: Clockwise (Fwd = C.W.)	x	-	B	-	B	
	F1-06	PG Division Rate PG --Pulse monitor (PG Output Ratio)	1~132	1	1	Effective only when control circuit board PG-B2 is used.	x	-	B	-	B	
	F1-07	Integral Value during Accel/decel Enable/disable (PG Ramp PII Sel)	0, 1	1	0	0: (Disabled) 1: (Enabled)	x	-	B	-	-	
	F1-08	Overspeed Detection Level (PG Overspd Level)	0~120	1%	115	—	x	-	A	-	A	
* When access level is BASIC (A1-03), constant is not displayed unless the option is connected.												

Function	Parameter No.	Name (Digital Operator Display)	Setting Range	Setting Unit	Factory Setting	Remarks (Digital Operator Display)	Change during Operation o: Enabled x: Disabled	Parameter Access Level				User Setting	
								V/f	V/f w/ PG	Open Loop Vector	Flux Vector		
Group F Options *	Function F1 PG Option Setup	F1-09	Overspeed Detection Delay Time (PG Overspd Time)	0.0~2.0	0.1s	0.0*	* When A1-02=1 [V/f w/PG] factory setting is 1.0. When A1-02=3 [Flux Vector] factory setting is 0.0.	x	-	A	-	A	
		F1-10	Excessive Speed Deviation Detection Level (PG Deviate Level)	0~50	1%	10	—	x	-	A	-	A	
		F1-11	Excessive Speed Deviation detection Delay Time (PG Deviate Time)	0.0~10.0	0.1s	0.5	—	x	-	A	-	A	
		F1-12	Number of PG Gear Teeth 1 (PG # Gear Teeth 1)	0~1000	1	0	—	x	-	A	-	-	
		F1-13	Number of PG Gear Teeth 2 (PG # Gear Teeth 2)	0~1000	1	0	—	x	-	A	-	-	
		F1-14	PGO Detection Time (PGO Detect Time)	0~10.0	0.1s	2.0	—	x	-	A	-	A	
	Function F2 AI-14 Setup	F2-01	AI-14B Card Input Selection (AI-14 Input Sel)	0, 1	1	0	0: (3-ch Individual) 1: (3ch Addition)	x	A	A	A	A	

* When access level is BASIC (A1-03), constant is not displayed unless the option is connected.

Function	Parameter No.	Name (Digital Operator Display)	Setting Range	Setting Unit	Factory Setting	Remarks (Digital Operator Display)	Change during Operation o: Enabled x: Disabled	Parameter Access Level				User Setting
								V/f	V/f w/ PG	Open Loop Vector	Flux Vector	
Group F Options * Function F3 DI-08, 16 Setup Function F4 AO-08, 12	F3-01	Digital Input Selection (DI Input)	0~7	1	0	0: (BCD 1%) 1: (BCD 0.1%) 2: (BCD 0.01%) 3: (BCD 1Hz) 4: (BCD 0.1Hz) 5: (BCD 0.01Hz) 6: BCD Special setting 5 digit input, Binary 255/100% (BCD (5DG) 0.01Hz) 7: (Binary)* *Set value is displayed as decimal.	x	A	A	A	A	
	F4-01	Channel 1 Monitor Selection (AO Ch1 Select)	1~38	1	2	Analog Output option Channel 1 1: Frequency reference 2: Output frequency 3: Inverter output current 5: Motor speed 6: Output voltage 7: DC bus voltage 8: Output power 9: Torque reference (internal) 15: External terminal 13 input voltage 16: External terminal 14 input voltage 17: External terminal 16 input voltage 18: Motor secondary current (Iq) 19: Motor excitation current (Id) 20: Primary frequency after SFS 21: Speed controller ASR input 22: Speed controller ASR output 23: Speed deviation 24: PID feedback 26: Voltage reference (Vq output) 27: Voltage reference (Vd output) 32: ACR (q) Output 33: ACR (d) Output 36: PID Input <1110> 37: PID Output <1110> 38: PID Reference <1110>	x	A	A	A	A	
	F4-02	Channel 1 Gain (AO Ch1 Gain)	0.00~2.50	0.01	1.00	—	o	A	A	A	A	
	F4-03	Channel 2 Monitor Selection (AO Ch2 Select)	1~38	1	3	Analog Output option Channel 2 selection (same as F4-01)	x	A	A	A	A	
	F4-04	Channel 2 Gain (AO Ch2 Gain)	0.00~2.50	0.01	0.50	—	o	A	A	A	A	
	F4-05 <1110>	CH1 Output Bias (AO Ch1 Bias)	-10.0~10.0	0, 1	0.0	—	o	A	A	A	A	
	F4-06 <1110>	CH2 Output Bias	-10.0~10.0	0, 1	0.0	—	o	A	A	A	A	
* When access level is BASIC (A1-03), constant is not displayed unless the option is connected.												

Appendix
VS-616G5 Parameter List F Options

Function	Parameter No.	Name (Digital Operator Display)	Setting Range	Setting Unit	Factory Setting	Remarks (Digital Operator Display)	Change during Operation o: Enabled x: Disabled	Parameter Access Level				User Setting	
								V/f	V/f w/ PG	Open Loop Vector	Flux Vector		
Group F Options	Function F5 DO - 02 Setup	F5-01	Channel 1 Output Selection (DO-02 Ch1 Select)	00-37	1	0	—	x	A	A	A	A	
		F5-02	Channel 2 Output Selection (DO-02 Ch2 Select)	00-37 <26>	1	1	—	x	A	A	A	A	
	Function F6 DO - 08 Setup	F6-01	Output Mode Selection (DO-08 Selection)	0, 1	1	0	0: (8ch Individual) 1: (Binary Output)	x	A	A	A	A	
	Function F7 PO - 36F Setup	F7-01	Frequency Multiple Selection (PO-36F Selection)	0-4	1	1	0: (1 X Output Freq) 1: (6 X Output Freq) 2: (10 X Output Freq) 3: (12 X Output Freq) 4: (36 X Output Freq)	x	A	A	A	A	
	Function F8 SI - F/G Setup	F8-01	SI-F/G Communication Error Detection Operation Selection (E-15 Det Sel)	0-3	1	1	0: (Ramp to Stop) 1: (Coast to Stop) 2: (Fast - Stop) 3: (Alarm Only)	x	A	A	A	A	
	Function F9 CP-916 Setup / DDS • SI-B	F9-01	Option External Fault Selection (EFO Selection)	0, 1	1	0	0: When 1 is shown, EFO occurs (Normally Open) 1: When 0 is shown, EFO occurs. (Normally Closed)	x	A	A	A	A	
		F9-02	Option External Fault Detection Selection (EFO Detection)	0, 1	1	0	0: (Always Detected) 1: (Only During Run)	x	A	A	A	A	
		F9-03	Option External Fault Detection Operation Selection (EFO Fault Action)	0-3	1	1	0: (Ramp to Stop) 1: (Coast to Stop) 2: (Fast - Stop) 3: (Alarm Only)	x	A	A	A	A	
		F9-04	Trace Sampling Time (Trace Sample Tim)	0-60000	1	0	—	x	A	A	A	A	
		F9-05	Torque Reference/Torque Limit Selection through DP-RAM communication (Torq Ref / Lmt Sel)	0, 1	1	1	0: (Disabled) 1: (Enabled)	x	-	-	-	A	
		F9-06	DP-RAM Communication Error Detection Operation Selection (BUS Fault Sel)	0-3	1	1	0: (Ramp to Stop) 1: (Coast to Stop) 2: (Fast - Stop) 3: (Alarm Only)	x	A	A	A	A	

Function	Parameter No.	Name (Digital Operator Display)	Setting Range	Setting Unit	Factory Setting	Remarks (Digital Operator Display)	Change during Operation o: Enabled x: Disabled	Parameter Access Level				User Setting
								V/f	V/f w/ PG	Open Loop Vector	Flux Vector	
Terminal Function Function H1: Digital Inputs	H1-01	Terminal 3 Selection (Terminal 3 Sel)	00~77	1	24	Multi-function input (terminal 3) 0: 3-Wire Control 1: Local/Remote Selection 2: Option/Inverter Selection 3: Multi-Step Reference 1 4: Multi-Step Reference 2 5: Multi-Step Reference 3 6: Jog Frequency Reference 7: Multi-Accel/Decel 1 8: External Baseblock N.O. 9: External Baseblock N.C. A: Accel/Decel Ramp Hold B: OH2 Alarm Signal C: Terminal 16 Enable D: V/F Mode Select E: ASR Integral Reset F: Terminal Not Used 10: MOP Increase 11: MOP Decrease 12: Forward Jog 13: Reverse Jog 14: Fault Reset 15: Fast-Stop N.O. 16: Motor 2 Select 17: Fast Stop N.C. input <1110> 18: Timer Function 19: PID Disable 1A: Multi-Accel/Decel 2 1B: Program Lockout 1C: Trim Control Increase 1D: Trim Control Decrease 1E: Ref Sample Hold 1F: Terminal 13/14 Switch 24: External Fault 30: PID Integral Reset 31: PID Control Integral Hold <1110> 60: DC Injection Activate 61: Speed Search 1 62: Speed Search 2 63: Energy Save Mode 64: Speed Search 3 65: KEB Ridethrough N.C. 66: KEB Ridethrough N.O 71: Speed/Torque Control Change 72: Zero Servo Command 77: ASR Gain Switch	x	B	B	B	B	
	H1-02	Terminal 4 Selection (Terminal 4 Sel)	00~77	1	14	Multi-function input (terminal 4) (same as H1-01)	x	B	B	B	B	
	H1-03	Terminal 5 Selection (Terminal 5 Sel)	00~77	1	3 (0) (Note 15)	Multi-function input (terminal 5) (same as H1-01)	x	B	B	B	B	

Appendix
VS-616G5 Parameter List H Terminals

Function	Parameter No.	Name (Digital Operator Display)	Setting Range	Setting Unit	Factory Setting	Remarks (Digital Operator Display)	Change during Operation o: Enabled x: Disabled	Parameter Access Level				User Setting
								V/f	V/f w/ PG	Open Loop Vector	Flux Vector	
	H1-04	Terminal 6 Selection (Terminal 6 Sel)	00-77	1	4 (3) (Note 15)	—	x	B	B	B	B	
	H1-05	Terminal 7 Selection (Terminal 7 Sel)	00-77	1	6 (4) (Note 15)	—	x	B	B	B	B	
	H1-06	Terminal 8 Selection (Terminal 8 Sel)	00-77	1	8 (6) (Note 15)	—	x	B	B	B	B	
Note 15: Factory settings in the parentheses are values obtained at 3-wire initialization.												

Function	Parameter No.	Name (Digital Operator Display)	Setting Range	Setting Unit	Factory Setting	Remarks (Digital Operator Display)	Change during Operation o: Enabled x: Disabled	Parameter Access Level				User Setting		
								V/f	V/f w/ PG	Open Loop Vector	Flux Vector			
Terminal	Function H2 Digital Outputs		H2-01	Multi-function Input Terminal 9-10 (Terminal 9 Sel)	00~37	1	0	Multi-function output 1 (terminal 9, terminal 10) (same as F5-01)	x	B	B	B	B	
	H2-02	Multi-function Input Terminal 25 (Terminal 25 Sel)	00~37	1	1	Multi-function output 2 (terminal 25, terminal 27) (same as F5-01)	x	B	B	B	B			
	H2-03	Multi-function Input Terminal 26 (Terminal 26 Sel)	00~37	1	2	Multi-function output 3 (terminal 26, terminal 27) (same as F5-01)	x	B	B	B	B			
	Function H3 Analog Inputs		H3-01	Signal Level Selection Terminal 13 (Term 13 Signal)	0, 1	1	0	0: (0 - 10 VDC) 1: (-10 +10 VDC)	x	B	B	B	B	
	H3-02	(Terminal 13 Gain)	0.0~1000.0	0.1%	100.0	Frequency reference gain of AI-14U, AI-14B (3ch addition input), DI-08, and DI-16 is common.	o	B	B	B	B			
	H3-03	(Terminal 13 Bias)	-100.0 ~ +100.0	0.1%	0.0	Frequency reference gain of AI-14U, AI-14B (3ch addition input), DI-08, and DI-16 is common.	o	B	B	B	B			
	H3-04	Terminal 16 Signal Level Selection (Term 16 Signal)	0, 1	1	0	0: (0 - 10 VDC) 1: (-10 +10 VDC)	x	B	B	B	B			
	H3-05	Terminal 16 Multi-function Analog Input (Terminal 16 Sel)	0~1F	1	0	Multi-function analog input selection (terminal 16) 0: Auxiliary Reference 1: Frequency Gain 2: Frequency Bias 4: Voltage Bias 5: Accel/Decel Change 6: DC Brake Current 7: Overtorque Level 8: Stall Prevention Level 9: Reference Lower Limit A: Jump Frequency B: PID Feedback C: PID Setpoint D: Frequency Bias 2 10: Forward Torque Limit 11: Reverse Torque Limit 12: Regenerative Torque Limit 13: Torque reference 14: Torque Compensation 15: Forward/Reverse Torque Limit 1F: Not Used	x	B	B	B	B			

Function	Parameter No.	Name (Digital Operator Display)	Setting Range	Setting Unit	Factory Setting	Remarks (Digital Operator Display)	Change during Operation o: Enabled x: Disabled	Parameter Access Level				User Setting
								V/f	V/f w/ PG	Open Loop Vector	Flux Vector	
Terminal Analog Inputs	H3-06	(Terminal 16 Gain)	0.0~1000.0	0.1%	100.0	—	o	B	B	B	B	
	H3-07	(Terminal 16 Bias)	-100.0 ~ +100.0	0.1%	0.0	—	o	B	B	B	B	
	H3-08	Signal Level Selection Terminal 14 (Term 14 Signal)	0, 1, 2	1	2	0: (0 - 10 VDC) 1: (-10 +10 VDC) 2: (4 - 20 mA)	x	A	A	A	A	
	H3-09	Multi-function Analog Input Terminal 14 (Terminal 14 Sel)	1~1F	1	1F	The function choices for terminal 14 are the same as the choices for terminal 16 [see H3-05], except that [setting 0] "Auxiliary Reference" is not available.	x	A	A	A	A	
	H3-10	Terminal 14 Gain (Terminal 14 Gain)	0.0~1000.0	0.1%	100.0	—	o	A	A	A	A	
	H3-11	Terminal 14 Bias (Terminal 14 Bias)	-100.0 ~ +100.0	0.1%	0.0	—	o	A	A	A	A	
	H3-12	Analog Input Filter Time Constant (Filter Avg Time)	0.00~2.00	0.01s	0.00	—	x	A	A	A	A	

Function	Parameter No.	Name (Digital Operator Display)	Setting Range	Setting Unit	Factory Setting	Remarks (Digital Operator Display)	Change during Operation o: Enabled x: Disabled	Parameter Access Level				User Setting
								V/f	V/f w/ PG	Open Loop Vector	Flux Vector	
Group H Terminal Function Function H4 Analog Outputs	H4-01	Monitor Selection Terminal 21 (Terminal 21 Sel)	1~38	1	2	Analog output selection (terminal 21 (same as F4-01) 1: Frequency reference 2: Output frequency 3: Inverter output current 5: Motor speed 6: Output voltage 7: DC bus voltage 8: Output power 9: Torque reference (internal) 15: External terminal 13 input voltage 16: External terminal 14 input voltage 17: External terminal 16 input voltage 18: Motor secondary current (Iq) 19: Motor excitation current (Id) 20: Primary frequency after SFS 21: Speed controller ASR input 22: Speed controller ASR output 23: Speed deviation 24: PID feedback 26: Voltage reference (Vq output) 27: Voltage reference (Vd output) 31: Not Used 32: ACR (q) Output 33: ACR (d) Output 36: PID Input <1110> 37: PID Output <1110> 38: PID Reference <1110>	x	B	B	B	B	
	H4-02	Terminal 21 Output Gain (Terminal 21 Gain)	0.00~2.50	0.01	1.00	—	o	B	B	B	B	
	H4-03	Terminal 21 Output Bias (Terminal 21 Bias)	-10.0~+10.0	0.0%	0.0	—	o	B	B	B	B	
	H4-04	Terminal 23 Monitor (Terminal 23 Sel)	1~38	1	3	Analog output selection (terminal 23) (same as H4-01)	x	B	B	B	B	
	H4-05	Terminal 23 Output Gain (Terminal 23 Gain)	0.00~2.50	0.01	0.50	—	o	B	B	B	B	
	H4-06	Terminal 23 Output Bias (Terminal 23 Bias)	-10.0~+10.0	0.1%	0.0	—	o	B	B	B	B	
	H4-07	Analog Output Signal Selection (AO Level Select)	0, 1	1	0	0: (0 - +10 VDC) 1: (-10V +10 VDC)	x	B	B	B	B	

Function	Parameter No.	Name (Digital Operator Display)	Setting Range	Setting Unit	Factory Setting	Remarks (Digital Operator Display)	Change during Operation o: Enabled x: Disabled	Parameter Access Level				User Setting
								V/f	V/f w/ PG	Open Loop Vector	Flux Vector	
Group H Terminal Function Function H5 Serial Com Setup MODBUS Communication	H5-01	Station Address (Serial Comm Adr)	0~20	1	1F	—	x	A	A	A	A	
	H5-02	Communication Speed Selection (Serial Baud Rate)	0~4	0	3	0 : (1200 Baud) 1 : (2400 Baud) 2 : (4800 Baud) 3 : (9600 Baud) 4 : (19200 Baud) <1110>	x	A	A	A	A	
	H5-03	Communication Parity Selection (Serial Com Sel)	0, 1, 2	1	0	0 : (No Parity) 1 : (Even Parity) 2 : (Odd Parity)	x	A	A	A	A	
	H5-04	Stopping Method After Communication Error (Serial Fault Sel)	0~3	1	3	0: (Ramp to Stop) 1: (Coast to Stop) 2: (Fast - Stop) 3: (Alarm Only)	x	A	A	A	A	
	H5-05	Timeover Detection (Serial Flt Dtct)	0, 1	1	1	0 : (Disabled) 1 : (Enabled)	x	A	A	A	A	
Protection Function L1 Motor Overload	L1-01	Motor Protection Selection (MOL Fault Select)	0, 1	1	1	0: (Disabled) 1: (Coast to Stop)	x	B	B	B	B	
	L1-02	Motor Protection Time Constant (MOL Time Const)	0.1~5.0 min.	0.1 min.	1.0	When O2-09=1 [American Spec] the setting range is 0.1~20min. The factory default setting then becomes 8 min. 8 min. is the operation time from a cold start.	x	B	B	B	B	
Protection Function L2 Power Loss Ride Through	L2-01	Momentary Power Loss Detection (PwrL Selection)	0, 1, 2	1	0	0 : (Disabled) 1 : Power loss ride through (PwrL RideThru t) 2 : (CPU Power Active)	x	B	B	B	B	
	L2-02	Momentary Power Loss Ride Through (PwrL Ridethru t)	0.0~2.0	0.1s	0.7**	** Factory setting differs depending on inverter capacity (02-04).	x	B	B	B	B	
	L2-03	Min. Baseblock Time (PwrL Baseblock t)	0.1~5.0	0.1s	0.5*	* Factory setting differs depending on inverter capacity. Lower limit of setting range is changed from 0 to 0.1. <1110>	x	B	B	B	B	
	L2-04	Voltage Recovery Time (PwrL V/F Ramp t)	0.0~5.0	0.1s	0.3*	* Factory setting differs depending on inverter capacity (02-04).	x	A	A	A	A	
	L2-05	Undervoltage Detection Level (PUV Det Level)	150~210	1V	190*	*Voltage Class 200V class=190V Det level 400V class=190V x 2= 380V level 575V class=190x575/200=546 level	x	A	A	A	A	
	L2-06	KEB Deceleration Rate (KEB Frequency)	0.0~100.0	0.1%	0.0	—	x	A	A	A	A	

Function	Parameter No.	Name (Digital Operator Display)	Setting Range	Setting Unit	Factory Setting	Remarks (Digital Operator Display)	Change during Operation o: Enabled x: Disabled	Parameter Access Level				User Setting
								V/f	V/f w/ PG	Open Loop Vector	Flux Vector	
Protection Function L3 Stall Prevention Function	L3-01	Stall Prevention During Acceleration (StallIP Accel Sel)	0, 1, 2	1	1	0: (Disabled) 1: (General Purpose) 2: (Intelligent)	x	B	B	B	-	
	L3-02	Stall Prevention Level During Acceleration (StallIP Accel Lvl)	0~200	1%	150	—	x	B	B	B	-	
	L3-03	Stall Prevention Limit During Acceleration (StallIP CHP Lvl)	0~100	1%	50	—	x	A	A	A	-	
	L3-04	Stall Prevention During Deceleration (StallIP Decel Sel)	0, 1, 2, 3	1	1	0: (Disabled) 1: (General Purpose) 2: (Intelligent) <1110> can use setting 2 for all control modes A102=0,1,2,3 3: With braking resistor (Stall prev w/R) When in Vector w/PG A1-02=3 setting 3 cannot be set with braking resistor and with stall prevention.	x	B	B	B	B	
	L3-05	Stall Prevention Selection during Running (StallIP Run Sel)	0, 1, 2	1	1	0: (Disabled) 1: (Decel Time 1) C1-02 2: (Decel Time 2) C1-04	x	B	B	-	-	
	L3-06	Stall Prevention Level during Running (StallIP Run Level)	30~200	1%	160	—	x	B	B	-	-	
	L3-07	Stall Prevention Function P Gain (StallIP Gain)	0.10~2.00	0.01	1.00	—	x	F	F	-	-	
	L3-08	Stall Prevention Function Integral Time (StallIP Intg Time)	10~250	1 ms	100	—	x	F	F	-	-	

Appendix
VS-616G5 Parameter List L Protection

Function	Parameter No.	Name (Digital Operator Display)	Setting Range	Setting Unit	Factory Setting	Remarks (Digital Operator Display)	Change during Operation o: Enabled x: Disabled	Parameter Access Level				User Setting	
								V/f	V/f w/ PG	Open Loop Vector	Flux Vector		
Protection	Function L4 Reference Detection	L4-01	Frequency Detection Level (Spd Agree Level)	0.0~400.0	0.1Hz	0.0	—	x	B	B	B	B	
		L4-02	Frequency Detection Width (Spd Agree Width)	0.0~20.0	0.1Hz	2.0	—	x	B	B	B	B	
		L4-03	Frequency Detection Level ± (Spd Agree Lvl ±)	-400.0 ~ +400.0	0.1Hz	0.0	—	x	A	A	A	A	
		L4-04	Frequency Detection Width ± (Spd Agree Wdth ±)	0.0~20.0	0.1Hz	2.0	—	x	A	A	A	A	
		L4-05	Frequency Loss Detection Selection (Ref Loss Sel)	0, 1	1	0	0: (Stop) 1: (Run@ 80% PrevRef)	x	A	A	A	A	
	Function L5 Fault Restart	L5-01	Number of Auto Restart Attempts (Num of Restarts)	0~10	1	0	—	x	B	B	B	B	
		L5-02	Auto Restart Operation Selection (Restart Sel)	0, 1	1	0	0: (No Flt Relay) 1: (Flt Relay Active)	x	B	B	B	B	
	Function L6 Torque Detection	L6-01	Overtorque Detection Selection 1 (Torq Det 1 Sel)	0~4	1	0	0: (Disabled) 1: (@SpdAgree - Alm) Detected during speed agree only. Operation continues after detection and OL3 flashes on display. 2: (At RUN - Alarm) Overtorque detection during running. Operation continues after detection and OL3 flashes on the display. 3: (@SpdAgree - Flt) Detected during the speed agree only. Inverter trips on OL3, output is shut OFF. 4: (At RUN - Fault) Detected during running, and the inverter trips on OL3. Output is shut OFF.	x	B	B	B	B	

Function	Parameter No.	Name (Digital Operator Display)	Setting Range	Setting Unit	Factory Setting	Remarks (Digital Operator Display)	Change during Operation o: Enabled x: Disabled	Parameter Access Level				User Setting	
								V/f	V/f w/ PG	Open Loop Vector	Flux Vector		
Protection	Function L6 Torque Detection	L6-02	Overtorque Detection Level 1 (Torq Det 1 Lvl)	0-300	1%	150	—	x	B	B	B	B	
		L6-03	Overtorque Detection Time 1 (Torq Det 1 Time)	0.0-10.0	0.1s	0.1	—	x	B	B	B	B	
		L6-04	Overtorque Detection Selection 2 (Torq Det 2 Sel)	0-4	1	0	0: (Disabled) 1: (@SpdAgree - Alm) Detected during speed agree only. Operation continues after detection and OL4 flashes on display. 2: (At RUN - Alarm) Overtorque detection during running. Operation continues after detection and OL4 flashes on the display. 3: (@SpdAgree - Flt) Detected during the speed agree only. Inverter trips on OL4, output is shut OFF. 4: (At RUN - Fault) Detected during running, and the inverter trips on OL4. Output is shut OFF.	x	A	A	A	A	
		L6-05	Overtorque Detection Level 2 (Torq Det 2 Lvl)	0-300	1%	150	—	x	A	A	A	A	
		L6-06	Overtorque Detection Time 2 (Torq Det 2 Time)	0.0-10.0	0.1s	0.1	—	x	A	A	A	A	
		Function L7 Torque Limit	L7-01	Forward Torque Limit (Torq Limit Fwd)	0-300	1%	200	—	x	-	-	B	B
	L7-02		Reverse Torque Limit (Torq Limit Rev)	0-300	1%	200	—	x	-	-	B	B	
	L7-03		Forward Regenerative Torque Limit (Torq Lmt Fwd Rgn)	0-300	1%	200	—	x	-	-	B	B	
	L7-04		Reverse Regenerative Torque Limit (Torq Lmt Rev Rgn)	0-300	1%	200	—	x	-	-	B	B	

Function	Parameter No.	Name (Digital Operator Display)	Setting Range	Setting Unit	Factory Setting	Remarks (Digital Operator Display)	Change during Operation o: Enabled x: Disabled	Parameter Access Level				User Setting
								V/f	V/f w/ PG	Open Loop Vector	Flux Vector	
Protection Function L8 Hardware Protection	L8-01	Internal DB Resistor Protection Selection (DB Resistor Prot)	0, 1	1	0	0: (Not Provided) 1: (Provided)	x	B	B	B	B	
	L8-02	Overheat Pre-alarm Level (OH Pre-Alarm Lvl)	50~130	1 deg C	95 C*	*Factory setting depends on inverter model [02-04].	x	A	A	A	A	
	L8-03	Operation Selection after OH Pre-alarm (OH Pre-Alarm Sel)	0~3	1	3	0: (Ramp to Stop) using C1-02 1: (Coast to Stop) 2: (Fast-Stop) using C1-09 3: (Alarm Only) display flashes OH Heatsink Ovrtemp	x	A	A	A	A	
	L8-05	Input Phase Loss Protection (PH Loss In Sel)	0, 1	1	0	0: (Disabled) 1: (Enabled)	x	A	A	A	A	
	L8-07	Output Phase Loss Protection (PH Loss Out Sel)	0, 1	1	0*	0: (Disabled) 1: (Enabled) *When 02-09=1, the factory default setting is 1.	x	A	A	A	A	
Protection Function L8 Hardware Protection	L8-10	Short-circuit Protection Selection (Ground Fault Sel)	0, 1	1	1	0: (Disabled) 1: (Enabled)	x	A	A	A	A	
	L8-17	IGBT Protection Selection at Low Frequency (Prct@L - Spd)	0, 1	1	1*	0: Conventional 1: (Lower fc) Carrier frequency is decreased when f _{out} ≤ 10Hz and the load is > 100% iac. 2: (Short term OL2) OL occurs after 2 seconds during low speed [f _{out} ≤ 6Hz] current limit. 3: (I-Limit=150%) Current limit is set to 150% of the inverter rated current. < G5 plus > Addition * When 02-09=1 factory setting is 1. * When 02-09=2 factory setting is 2.	x	A	A	A	-	
	L8-19 <1110>	OL2 Characteristics Selection at Low Speed (OL2 Chara@L-Spd)	0, 1	1	0	0: (Disabled) Low frequency OL disabled 1: (Enabled) Low frequency OL enabled	x	A	A	A	A	

Function	Parameter No.	Name (Digital Operator Display)	Setting Range	Setting Unit	Factory Setting	Remarks (Digital Operator Display)	Change during Operation o: Enabled x: Disabled	Parameter Access Level				User Setting	
								V/f	V/f w/ PG	Open Loop Vector	Flux Vector		
Operator	Function o1 Monitor Selection					Monitor selection 4: Control method 5: Motor speed 6: Output voltage 7: DC bus voltage 8: Output power 9: Torque reference (internal) 10: Input terminal status 11: Output terminal status 12: Internal Control Status 1 13: Elapsed time 14: Flash software ID number 15: External terminal 13 input voltage 16: External terminal 14 input voltage 17: External terminal 16 input voltage 18: Motor secondary current (Iq) 19: Motor excitation current (Id) 20: Primary frequency after SFS 21: Speed controller ASR input 22: Speed controller ASR output 23: Speed deviation 24: PID feedback 25: DI-16 reference 26: Voltage reference (Vq output) 27: Voltage reference (Vd output) 28: CPU ID number	o	B	B	B	B		
		O1-01	Monitor Selection (User Monitor Sel)	4~39	1	6							
	Function o2 Key Selections						1: (Frequency Ref) 2: (Output Freq) 3: (Output Current) 4: (User Monitor)	o	B	B	B	B	
		O1-02	Monitor Selection after Power Up (Power-On Monitor)	1~4	1	1							
		O1-03	Frequency Units of Reference Setting and Monitor (Display Scaling)	0~39999	1	0	—	x	B	B	B	B	
		O1-04	(Display Units)	0, 1	1	0	0: (Hertz) 1: (RPM)	x	-	-	-	B	
		O1-05	Parameter No. Display Selection (Address Display)	0, 1	1	0	0: (Parameter Number) 1: (Memobus Address)	x	A	A	A	A	
		O2-01	LOCAL/REMOTE Key Enable/Disable (Local/Remote Key)	0, 1	1	1	0: (Disabled) 1: (Enabled)	x	B	B	B	B	
	O2-02	STOP Key Function Selection (Oper STOP Key)	0, 1	1	1	0: (Disabled) When the inverter is operated from the digital operator. 1: (Enabled) Always enabled.	x	B	B	B	B		

Function	Parameter No.	Name (Digital Operator Display)	Setting Range	Setting Unit	Factory Setting	Remarks (Digital Operator Display)	Change during Operation o: Enabled x: Disabled	Parameter Access Level				User Setting
								V/f	V/f w/ PG	Open Loop Vector	Flux Vector	
Operator Function o2 Key Selection	02-03	User Parameter Initialization Selection (User Defaults)	0, 1, 2	1	0	0: (No Change) Yaskawa default values used 1: (Set Defaults) Sets user specified value as default. 2: (Clear All) Clears user defaults	x	B	B	B	B	
	02-04	kVA Selection (Inverter Model #)	0~FF	1	—*	* Not initialized. Sets the inverter capacity according to the model number.	x	B	B	B	B	
	02-05	Frequency Reference Setting Method Selection (Operator M.O.P.)	0, 1	1	0	0: (Disabled) 1: (Enabled)	x	A	A	A	A	
	02-06	Operation Selection When Digital Operator is Disconnected (Oper Detection)	0, 1	1	0*	0: (Disabled) Operation continues even if the digital operator is disconnected. 1: (Enabled) Inverter fault when the digital operator is disconnected. * When 02-09=1, the value is 1.	x	A	A	A	A	
	02-07	Elapsed Timer Setting (Elapsed Time Set)	0~65535	1 hour	—	—	x	A	A	A	A	
	02-08	Elapsed Timer Selection (Elapsed Time Run)	0, 1	1	0	0: (Power - On Time) 1: (Running Time)	x	A	A	A	A	
	02-09	Initialization Mode Selection (Init Mode Sel)	0~3	1	0	0: (Japanese spec) 1: (American spec) 2: (European spec) 3: (OMRON spec) When 02-09 = 1 or 2, it is added by <1032>. When 02-09 = 0 or 3, it is added by <1040>.	x	A	A	A	A	

2. Monitor Display (Un-XX)

Function	Parameter No.	Name (Digital Operator Display)	Min. Unit	Description	Analog Monitor Output Level	Parameter Access Level			
						V/f	V/f w/ PG	Vector w/o PG	Vector w/ PG
Monitor	U1-01	Frequency Reference (Frequency Ref)	0.01Hz	The unit differs depending on O1-03 setting.	10V/Max. output frequency	Q	Q	Q	Q
	U1-02	Output Frequency (Output Freq)	0.01Hz	The unit differs depending on O1-03 setting.	10V/Max. output frequency	Q	Q	Q	Q
	U1-03	Output Current (Output Current)	0.1A	Minimum unit is 0.01 A for 7.5 kW or less.	10V/Inverter rated current	Q	Q	Q	Q
	U1-04	Control Method* (Control Method)	—	0: V/f control 1: V/f control with PG 2: Vector control without PG 3: Vector control with PG	—	Q	Q	Q	Q
	U1-05	Motor Speed (Motor Speed)	0.01Hz	The unit differs depending on O1-03 setting.	10V/Max. output frequency	x	Q	Q	Q
	U1-06	Output Voltage (Output Voltage)	0.1V	—	10V/200V or 400V ?575	Q	Q	Q	Q
	U1-07	DC Bus Voltage V (DC Bus Voltage)	1V	—	10V/400V or 800V	Q	Q	Q	Q
Monitor	U1-08	Output Power (Output kWatts)	0.1kW	—	10V/Inverter capacity (kW)	Q	Q	Q	Q
	U1-09	Torque Reference (Torque Reference)	0.1%	—	10V/Motor rated torque	x	x	Q	Q
	U1-10	Input Terminal Status* (Input Term Sts)	—	<p style="margin-left: 40px;"> 0 0 0 0 0 0 0 0 1: T1 "Closed" 1: T2 "Closed" 1: T3 "Closed" 1: T4 "Closed" 1: T5 "Closed" 1: T6 "Closed" 1: T7 "Closed" 1: T8 "Closed" </p>	—	Q	Q	Q	Q
U1-11	Output Terminal Status* (Output Term Sts)	—	<p style="margin-left: 40px;"> 0 0 0 0 0 0 0 0 0 0 1: T9~ 10 "Closed" 1: T25 "Closed" 1: T26 "Closed" 0: Not used 0: Not used 0: Not used 0: Not used 1: Fault </p>	—	Q	Q	Q	Q	

* Cannot be changed by U1-04

Function	Parameter No.	Name (Digital Operator Display)	Min. Unit	Description	Analog Monitor Output Level	Parameter Access Level			
						V/f	V/f w/ PG	Vector w/o PG	Vector w/ PG
Monitor	U1-12	Operation Status* (Int Ctl Sts 1)	—		—	Q	Q	Q	Q
	U1-13	Elapsed Time* (Elapsed Time)	1 hour	—	—	Q	Q	Q	Q
	U1-14	Software No. at FLASH Side* (FLASH ID)	—	—	—	Q	Q	Q	Q
	U1-15	Control Circuit Terminal 13 (Term 13 Level)	0.1%	—	10V/10V	B	B	B	B
	U1-16	Control Circuit Terminal 14 Input Voltage (Term 14 Level)	0.1%	—	10V/10V or 20 mA	B	B	B	B
	U1-17	Control Circuit Terminal 16 Input (Terminal 16 Level)	0.1%	—	10V/10V	B	B	B	B
	U1-18	Motor Secondary Current (Iq) (Mot SEC Current)	0.1%	—	10V/Motor rated primary current	B	B	B	B
	U1-19	Motor Excitation Current (Mot EXC Cur- rent)	0.1%	—	10V/Motor rated primary current	x	x	B	B
	U1-20	Output Frequency after Soft-start (SFS Output)	0.01Hz	—	10V/Max. output frequency	A	A	A	A
	U1-21	ASR Input (ASR Input)	0.01%	—	10V/Max. output frequency	x	A	x	A
	U1-22	ASR Output (ASR Output)	0.01%	Analog monitor output level becomes 10V/Max. out- put frequency for V/f control mode with PG.	10V/Motor rated primary current	x	A	x	A
	U1-23	Speed Deviation (Speed Deviation)	0.01%	—	10V/Max. output Frequency	x	A	x	A
U1-24	PID Feedback Capacity (PID Feedback)	0.01%	—	10V/Max. output Frequency	A	A	A	A	

* Cannot be changed by U1-04

Function	Parameter No.	Name (Digital Operator Display)	Min. Unit	Description	Analog Monitor Output Level	Parameter Access Level			
						V/f	V/f w/ PG	Vector w/o PG	Vector w/ PG
Monitor	U1-25	D1-16H Input Status* (DI-16 Reference)	—	Displays input value according to F3-01 setting. For example: When lower 8 bit is ON, Binary selection: 256, BCD selection: 99	—	A	A	A	A
	U1-26	Output Voltage Reference Vq (Voltage Ref (Vq))	0.1V	—	10V/200V or 400V	x	x	A	A
	U1-27	Output Voltage Reference Vd (Voltage Ref (Vd))	0.1V	—	10V/200V or 400V	x	x	A	A
	U1-28	Software No. at CPU Side* (CPU ID)	—	—	—	A	A	A	A
	U1-32	ACR (q) Output (ACR (q) Output)	0.1%	—	—	x	x	A	A
	U1-33	ACR (d) Output (ACR (d) Output)	0.1%	—	—	x	x	A	A
	U1-34	OPE Detection Parameter* (OPE Detected)	—	—	—	A	A	A	A
	U1-35	No. of O Servo Moving Pulses (Zero Servo Pulse)	1	—	—	x	x	x	A
	U1-36 <1110>	PID Deviation (PID Input)	0.01%	PID reference + PID reference bias – PID feedback capacity	10V/Max. Output Frequency	A	A	A	A
	U1-37 <1110>	PID Output Capacity (PID Output)	0.01%	PID output capacity	10V/Max. Output Frequency	A	A	A	A
	U1-38 <1110>	PID Reference (PID Setpoint)	0.01%	PID reference + PID reference bias	10V/Max. Output Frequency	A	A	A	A
	U1-39 <1110>	Temperature for Cooling Fin (Heatsink Temp)	1°C	—	—	F	F	F	F

* Cannot be changed by U1-04

Function	Parameter No.	Name (Digital Operator Display)	Min. Unit	Description	Analog Monitor Output Level	Parameter Access Level			
						V/f	V/f w/ PG	Vector w/o PG	Vector w/ PG
Function U2 Fault Trace	U2-01	Current Fault (Current Fault)	—	—	—	Q	Q	Q	Q
	U2-02	Last Fault (Last Fault)	—	—	—	Q	Q	Q	Q
	U2-03	Frequency Reference at Fault (Frequency Ref)	0.01Hz	—	—	Q	Q	Q	Q
	U2-04	Output Frequency at Fault (Output Freq)	0.01Hz	—	—	Q	Q	Q	Q
	U2-05	Output Current at Fault (Output Current)	0.1A	—	—	Q	Q	Q	Q
	U2-06	Motor Speed at Fault (Motor Speed)	0.01Hz	—	—	x	Q	Q	Q
	U2-07	Output Voltage Reference at Fault (Output Voltages)	0.1V	—	—	Q	Q	Q	Q
	U2-08	DC Bus Voltage at Fault (DC Bus Voltage)	1V	—	—	Q	Q	Q	Q
	U2-09	Output Power at Fault (Output kWatts)	0.1kW	—	—	Q	Q	Q	Q
	U2-10	Torque Reference at Fault (Torque Reference)	0.1%	—	—	x	x	Q	Q
	U2-11	Input Terminal Status at Fault (Input Term Sts)	—	Displays the same status as the U1-10.	—	Q	Q	Q	Q
	U2-12	Output Terminal Status at Fault (Output Term Sts)	—	Displays the same status as the U1-11.	—	Q	Q	Q	Q
	U2-13	Operation Status at Fault (Inverter Status)	—	Displays the same status as the U1-12.	—	Q	Q	Q	Q
	U2-14	Elapsed Operation Time at Fault (Elapsed Time)	1 hour	—	—	Q	Q	Q	Q

Function	Parameter No.	Name (Digital Operator Display)	Min. Unit	Description	Analog Monitor Output Level	Parameter Access Level			
						V/f	V/f w/ PG	Vector w/o PG	Vector w/ PG
Function U3 Fault History	U3-01	Most Recent Fault (Last Fault)	—	—	—	Q	Q	Q	Q
	U3-02	Second Most Recent Fault (Fault Message 2)	—	—	—	Q	Q	Q	Q
	U3-03	Third Most Recent Fault (Fault Message 3)	—	—	—	Q	Q	Q	Q
	U3-04	Fourth/oldest Fault (Fault Message 4)	—	—	—	Q	Q	Q	Q
	U3-05	Elapsed Operation Time at Fault (Elapsed Time 1)	1 hour	—	—	Q	Q	Q	Q
	U3-06	Elapsed Time of Second Fault (Elapsed Time 2)	1 hour	—	—	Q	Q	Q	Q
	U3-07	Elapsed Time of Third Fault (Elapsed Time 3)	1 hour	—	—	Q	Q	Q	Q
	U3-08	Elapsed Time of Fourth/oldest Fault (Elapsed Time 4)	1 hour	—	—	Q	Q	Q	Q

YASKAWA ELECTRIC AMERICA, INC.

Chicago-Corporate Headquarters 2121 Norman Drive South, Waukegan, IL 60085, U.S.A.
Phone: (847) 887-7000 Fax: (847) 887-7310 Internet: <http://www.yaskawa.com>

MOTOMAN INC.

805 Liberty Lane, West Carrollton, OH 45449, U.S.A.
Phone: (937) 847-6200 Fax: (937) 847-6277

YASKAWA ELECTRIC CORPORATION

New Pier Takeshiba South Tower, 1-16-1, Kaigan, Minatoku, Tokyo, 105-0022, Japan
Phone: 81-3-5402-4511 Fax: 81-3-5402-4580 Internet: <http://www.yaskawa.co.jp>

YASKAWA ELETRICO DO BRASIL COMERCIO LTDA.

Avenida Fagundes Filho, 620 Bairro Saude Sao Paulo-SP, Brasil CEP: 04304-000
Phone: 55-11-5071-2552 Fax: 55-11-5581-8795 E-mail: yaskawabrasil@originet.com.br

YASKAWA ELECTRIC EUROPE GmbH

Am Kronberger Hang 2, 65824 Schwalbach, Germany
Phone: 49-6196-569-300 Fax: 49-6196-888-301 Internet: <http://www.yaskawa.de>

MOTOMAN ROBOTICS AB

Box 504 S38525, Torsas, Sweden
Phone: 46-486-48800 Fax: 46-486-41410

MOTOMAN ROBOTEC GmbH

Kammerfeldstraße 1, 85391 Allershausen, Germany
Phone: 49-8166-900 Fax: 49-8166-9039

YASKAWA ELECTRIC UK LTD.

1 Hunt Hill Orchardton Woods Cumbernauld, G68 9LF, Scotland, United Kingdom
Phone: 44-12-3673-5000 Fax: 44-12-3645-8182

YASKAWA ELECTRIC KOREA CORPORATION

Paik Nam Bldg, 901 188-3, 1-Ga Euljiro, Joong-Gu, Seoul, Korea
Phone: 82-2-776-7844 Fax: 82-2-753-2639

YASKAWA ELECTRIC (SINGAPORE) PTE. LTD.

Head Office: 151 Lorong Chuan, #04-01, New Tech Park Singapore 556741, SINGAPORE
Phone: 65-282-3003 Fax: 65-289-3003

TAIPEI OFFICE (AND YATEC ENGINEERING CORPORATION)

10F 146 Sung Chiang Road, Taipei, Taiwan
Phone: 886-2-2563-0010 Fax: 886-2-2567-4677

YASKAWA JASON (HK) COMPANY LIMITED

Rm. 2909-10, Hong Kong Plaza, 186-191 Connaught Road West, Hong Kong
Phone: 852-2803-2385 Fax: 852-2547-5773

BEIJING OFFICE

Room No. 301 Office Building of Beijing International Club, 21
Jianguomanwai Avenue, Beijing 100020, China
Phone: 86-10-6532-1850 Fax: 86-10-6532-1851

SHANGHAI OFFICE

27 Hui He Road Shanghai 200437 China
Phone: 86-21-6553-6600 Fax: 86-21-6531-4242

SHANGHAI YASKAWA-TONJI M & E CO., LTD.

27 Hui He Road Shanghai 200437 China
Phone: 86-21-6533-2828 Fax: 86-21-6553-6677

BEIJING YASKAWA BEIKE AUTOMATION ENGINEERING CO., LTD.

30 Xue Yuan Road, Haidian, Beijing 100083 China
Phone: 86-10-6232-9943 Fax: 86-10-6234-5002

SHOUGANG MOTOMAN ROBOT CO., LTD.

7, Yongchang-North Street, Beijing Economic & Technological Development Area,
Beijing 100076 China
Phone: 86-10-6788-0551 Fax: 86-10-6788-2878